



Contents

General Warnings	2	MROF eyes on/off	13
Switching on your Angel	3	Breakout	14
Turning the Angel off	3	Ramp	14
Navigation switch	4	Shot % filtering	14
Replacing the 9v battery	4	Anti bolt stick	15
Switching Angel eyes on/off	5	Software version	15
OPTO board	5	Factory reset	15
Macro line hose	5	Game timer alarm	16
Propellant air/nitrogen supply	6	Tournament lock	16
Adjusting the ASA position	6	General care and cleaning	
Installing an air nitrogen system	6	Left & right cut-aways	17
Bolt removal and rotor breech	7	General assemblies	18-19
Velocity adjustment	7	In-line regulator service & assembly	20
OLED menu	8-9	Rubber finger detent	21
Modes		Angel eyes servicing	22
Semi Auto	10	Angel eyes removal	23
NPPL	10	LPR adjustment	24
PSP	10	LPR assembly removal & replacement	25
MILLENNIUM	10	LPR spool removal	26
XBall/NXL	10	Exhaust valve guide removal	27
CFOA	11	Exhaust valve stem removal	27
Full Auto	11	Ram removal	28
Demo	11	Magnetic force trigger adjustment	29
Custom Semi	11	Front and back stop position adjustment	29
Breakout	11	Trigger activation position	30
Soft breakout	11	Wiring connections	30
Hard breakout	11	Fault finding	31-32
Ramp	12	Useful conversions	31
Parameters		Warranty - EEC/ROW	33-34
Valve dwell	12	Warranty - USA/Canada	35-36
De-Bounce	12	Warranty card	37
Loader speed delay	13		



- This Operator's and User's Manual is in English.
- It contains important safety guidelines and instructions.
- Should you be unsure at any stage, or unable to understand the contents within this manual you must seek expert advice.



- Le mode d'emploi est en Anglais.
- Il contient des instructions et mesures de sécurité importantes.
- En cas de doute, ou s'il vous est impossible de comprendre le contenu du mode d'emploi, demandez conseil à un expert.



- Este manual de (operarios y) usuarios está en Inglés.
- Contiene importantes normas de seguridad e instrucciones.
- Si no está seguro de algún punto o no entiende los contenidos de este manual debe consultar con un experto.



- Diese Bedienungs- und Benutzeranleitung ist in Englisch.
- Sie enthält wichtige herheftsrichtlinien und -bestimmungen.
- Sollten Sie sich in irgendeiner Weise unsicher sein, oder den Inhalt dieses Heftes nicht verstehen, lassen Sie sich bitte von einem Experten beraten.



WARNING

ADHERE STRICTLY TO THESE AND ALL OTHER SAFETY INSTRUCTIONS AND GUIDELINES

- The ANGEL is not a toy.
- Careless or improper use, including failure to follow instructions and warnings within this Operator Manual and attached to the ANGEL could cause death or serious injury.
- Do not remove or deface any warnings attached to the ANGEL.
- Paintball industry standard eye/face/ear and head protection designed specifically to stop paintballs and meeting ASTM standard F1776 (USA) or CE standard (Europe) must be worn by user and any person within range.
- Must be at least 18 years of age to purchase the ANGEL.
- Persons under 18 years of age must have adult supervision when using or handling the ANGEL.
- Observe all local and national laws, regulations and guidelines.
- Use only on professional paintball fields where codes of safety are strictly enforced.
- Use 0.68 calibre paintballs only.
- Keep the ANGEL switched off until ready to shoot.
- Treat every Angel as if it is loaded.
- Never point the ANGEL at anything you do not intend to shoot.
- Do not shoot at persons at close range.
- Do not shoot at fragile objects such as windows.
- Always measure your Angels velocity before playing paintball, using a suitable chronograph.
- Never shoot at velocities in excess of 300 feet (92 meters) per second, or at velocities greater than local or national laws allow.
- Do not fire the ANGEL with the breech open or without the bolt in the breech, as high pressure gas will be emitted.
- Use compressed air/nitrogen gas only. Do not use CO2.
- Do not exceed 850 psi (58 bar) input pressure.
- Always follow instructions, warnings and guidelines given with any first stage regulator you use with the ANGEL.
- Do not fire the ANGEL with the breech release knob in the unlocked position.
- Never look into the barrel or breech area of the ANGEL whilst the Angel is switched on and able to fire.
- Never put your finger or any foreign objects into the breech or paintball feed tube of the ANGEL
- Never allow pressurised gas to come into contact with any part of your body.
- Always switch off the ANGEL when not in use.
- Always fit a barrel blocking device to your ANGEL when not in use on the field of play.
- Always remove all paintballs from the ANGEL when not in use on the field of play.
- Always remove the first stage regulator and relieve all residual gas pressure from the ANGEL before disassembly.
- The ANGEL can hold a small residual charge of gas, typically 2 shots, with the first stage regulator removed. Always discharge the Angel in a safe direction to relieve this residual gas pressure.
- Always remove first stage regulator and all residual gas pressure from the ANGEL for transport and storage.
- Always follow warnings and guidelines given with your first stage regulator for safe transport and storage.
- Always store the ANGEL in a secure place.
- **THIS OPERATOR'S MANUAL MUST ALWAYS ACCOMPANY THE PRODUCT IN THE EVENT OF RESALE OR NEW OWNERSHIP.**
- **SHOULD YOU BE UNSURE AT ANY STAGE YOU MUST SEEK EXPERT ADVICE.**

Switching on your Angel

WARNING

ADHERE STRICTLY TO THESE AND ALL OTHER SAFETY INSTRUCTIONS AND GUIDELINES

• Angel is LIVE and capable of firing.

To switch the Angel on press and hold the navigation switch **1** inwards for up to 2 seconds. The Angel will turn on and will automatically go into LIVE mode with the eyes on. The display screen will illuminate and will show the firing Status of the Angel.

The LED on the rear of the grip frame will show blue.

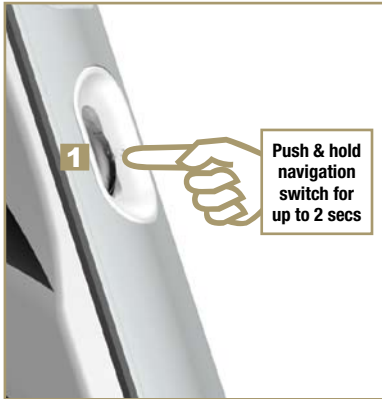

Screen shows Eyes off and eyes are faulty.



Screen shows Eyes off and no ball present.

Turning the Angel off

Switch the Angel off by pressing and holding the navigation switch **1** in for 1 second. A goodbye message will be displayed on the screen and the Angel will power down.

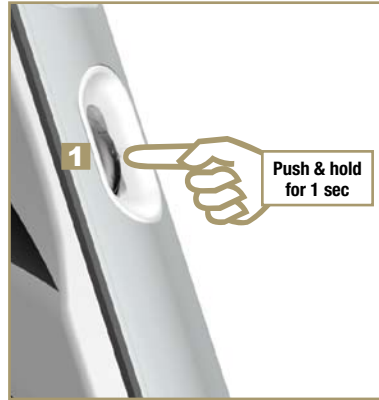

Making the Angel SAFE

When you turn the Angel on the Angel is LIVE. To make the Angel SAFE, either:

- Access the menu options by pushing the navigation upwards and holding for 1.5 sec. This automatically puts the Angel in SAFE.
- Choose **SAFE** from the menu options.

When the Angel is SAFE a screen similar to that below will show. The screen will indicate the Angel is SAFE. The screen will also indicate the mode you are in and whether the tournament lock is on or off. (See page 16).



ANGEL 1

3

WARNING

ADHERE STRICTLY TO THESE AND ALL OTHER SAFETY INSTRUCTIONS AND GUIDELINES

- Ensure a barrel blocking device is fitted to the ANGEL.
- Ensure the hopper is removed from the ANGEL.
- Ensure that there are no paintballs in the ANGEL.
- Paintball industry standard eye/face/ear and head protection designed specifically to stop paintballs and meeting ASTM standard F1776 (USA) or CE standard (Europe) must be worn by user and any person within range.
- SHOULD YOU BE UNSURE AT ANY STAGE YOU MUST SEEK EXPERT ADVICE.

⚠ WARNING**ADHERE STRICTLY TO THESE
AND ALL OTHER SAFETY
INSTRUCTIONS AND GUIDELINES**

- Ensure a barrel blocking device is fitted to the ANGEL.
- Ensure the hopper is removed from the ANGEL.
- Ensure that there are no paintballs in the ANGEL.
- Paintball industry standard eye/face/ear and head protection designed specifically to stop paintballs and meeting ASTM standard F1776 (USA) or CE standard (Europe) must be worn by user and any person within range.
- SHOULD YOU BE UNSURE AT ANY STAGE YOU MUST SEEK EXPERT ADVICE.

Navigation switch

The functions, features and settings of the Angel are controlled by a 3 directional navigation switch located on the rear of the grip frame. The switch can move up and down to scroll through features and settings indicated on the display and can be pressed in to select the highlighted function or setting required.

**Replacing the 9v battery**

- Ensure that the Angel is off.
- If required switch the Angel off by pressing and holding the navigation switch in for 1 second. A goodbye message will be displayed on the screen and the Angel will power down.
- Remove the right hand grip cheek **1** by removing the 3 screws **2** using a suitable 2mm Allen key.
- If a battery is already present carefully lift the battery **3** from its housing.
- Observe the battery polarity as marked on the battery housing terminal and on the battery.

Always use a good quality fresh battery.

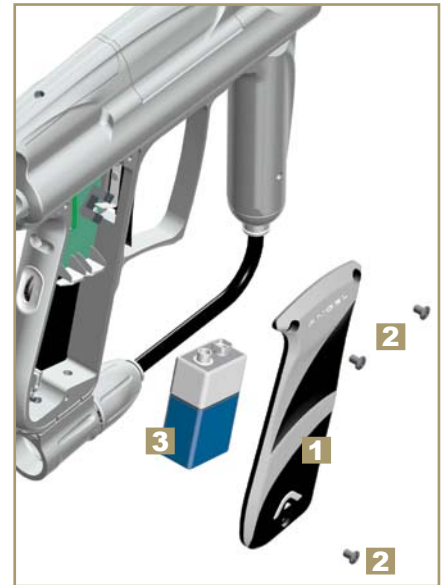

Switching Angel eyes OFF/ON

⚠️ WARNING

ADHERE STRICTLY TO THESE AND ALL OTHER SAFETY INSTRUCTIONS AND GUIDELINES

• THE ANGEL IS LIVE AND CAPABLE OF DISCHARGING.

- Ensure that the Angel is on (see page 3).
- As default the Angel Eyes will always be ON whenever the Angel is switched ON.
- The Angel eyes can be switched off by pulling the trigger **1** for 1 second. The Angel's MROF will drop to its default MROF eyes off setting. It will fire 1 shot to confirm that the eyes have been switched off and the buzzer will sound once. The eyes off symbol will be displayed on the display screen.
- To turn the Angel eyes back on pull and hold the trigger **1** again for 2 seconds. The MROF will return to MROF eyes on setting (see page 15 for factory default setting), the buzzer will sound twice the eyes on symbol will be displayed on the display screen.
- Should the eyes detect a malfunction due to a component failure or the eyes becoming dirty they will automatically turn themselves off and the MROF will revert to its MROF eyes off setting (see page 15 for factory default setting), the display will indicate that the eyes are off and that a ball is not detected.

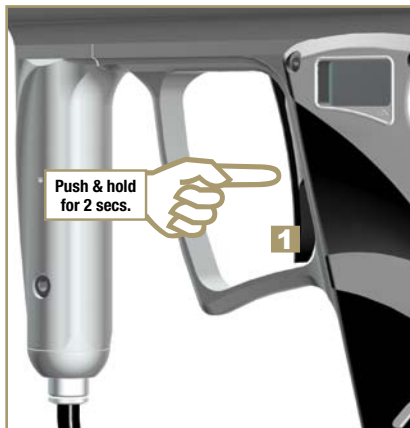

OPTO board

The Angel incorporates the OPTO board. This board is the latest development in trigger sensing function. It achieves unsurpassed advancements in trigger repeatability and sensitivity, its friction free non mechanical operating switch results in faster shorter and lighter trigger strokes that give the user higher prolonged achievable rates of fire.

Macro line hose

- The Macro line hose may be removed from the Macro line connectors to facilitate maintenance.
- Pull back the collet **1** on the connector and keep the collet depressed.
- Pull the Macro line hose **2** out of the connector firmly.
- Cut back the Macro line hose cleanly and square **3**.
- Push the hose firmly into the Macro line connector to re-attach.

Important Note:

Please make sure that the macro-line is trimmed back before re-insertion after it has been removed.

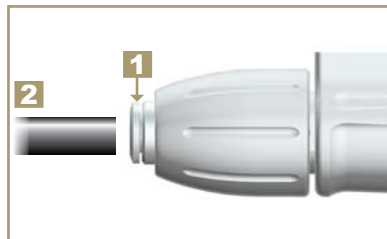
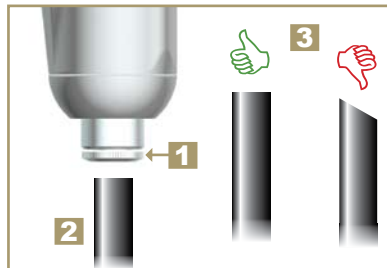

ANGEL 1



⚠️ WARNING

ADHERE STRICTLY TO THESE AND ALL OTHER SAFETY INSTRUCTIONS AND GUIDELINES

- Ensure a barrel blocking device is fitted to the ANGEL.
- Ensure the hopper is removed from the ANGEL.
- Ensure that there are no paintballs in the ANGEL.
- Paintball industry standard eye/face/ear and head protection designed specifically to stop paintballs and meeting ASTM standard F1776 (USA) or CE standard (Europe) must be worn by user and any person within range.
- SHOULD YOU BE UNSURE AT ANY STAGE YOU MUST SEEK EXPERT ADVICE.

! WARNING**ADHERE STRICTLY TO THESE AND ALL OTHER SAFETY INSTRUCTIONS AND GUIDELINES**

- Always follow instructions, warnings and guidelines given with any first stage regulator you use with the ANGEL.
- Use compressed air/nitrogen gas only DO NOT USE CO2.
- Only use a paintball regulator that has been designed for air or nitrogen gas.
- Do not exceed 850 psi (58bar) input pressure to the ANGEL.
- Take suitable precautions when using sharp cutting instruments.
- The Macro Line hose must be cut back cleanly and square prior to attachment or re-attachment to ensure secure fitment.
- SHOULD YOU BE UNSURE AT ANY STAGE YOU MUST SEEK EXPERT ADVICE.

Propellant air/nitrogen supply

The Angel is designed to operate on air/Nitrogen gas. This needs to be supplied to the Angel at an ideal pressure of 400psi (27.5 bar) using a suitable first stage regulator.

Adjusting the ASA position on its mounting rail

The ASA connects to the grip frame of the Angel via an integrated dovetail mounting rail **1** that allows the user to slide the ASA body along the rail to fine tune the mounting position of the ASA. The ASA body is locked down onto the rail via two set screws **2** located within a central recess at the front and back of the integrated rail, in order to move the ASA along the rail you need to loosen off the two set screws **2** using a 3mm Allen key, once the desired position of the ASA has been achieved tighten the set screws **2** to lock the ASA into position on the integrated rail.

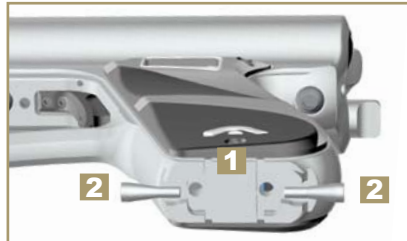
**Installing an air nitrogen system**

Each Angel comes complete with a centrally ported on/off Angel ASA allowing for the easy connection of a preset air/nitrogen system for immediate use.

Before installing your pre-set system into the Angel ASA always ensure that the on/off adjuster knob **3** is wound out approximately half way.

Be careful not to unscrew the ASA on/off adjuster knob too far as it is possible to completely disassemble the ASA. If this happens replace the on/off adjuster knob by screwing it back on to the ASA main body in a clock wise motion.

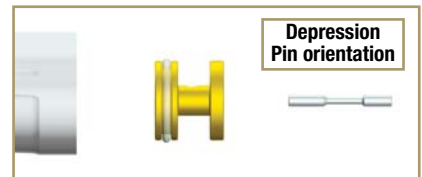
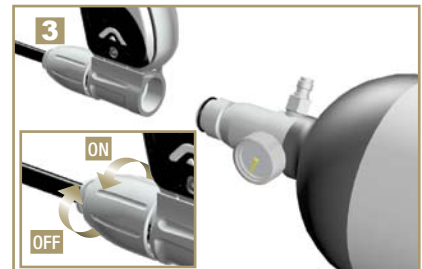

Bolt removal and rotor breach

The outer wear surfaces of the Bolt are made from acetate (homopolymer) and the inner core is made from glass re-enforced nylon. This is to ensure – due to its high cycling speeds- the bolt does not seize within the body. Eventually the bolt will show signs of wear but this is dependant on its usage and the environmental conditions.

It is important that the bolt is kept clean and free from dirt or grit and that it is run dry with no lubricant. We recommend that you clean your bolt after each day of use.

Bolt removal is best achieved whilst the angel is gassed up as this ensures that the ram is in the rearward position ready for the bolt to be extracted.

- Ensure that the Angel is off or that it is in safe mode.
- Rotate the breach release knob **1** clockwise until it stops.

NOTE: The breach block WILL NOT OPEN when the Angel is de-gassed and the ram and bolt are in the forward position. To allow the breach to rotate open, insert a squeegee into the barrel bore and manually push the bolt back.

- Swing out the rotor breach block **2** so that the bolt is exposed.
- Extract the bolt **3** by pulling it backwards.
- To replace the bolt follow the steps in reverse order.

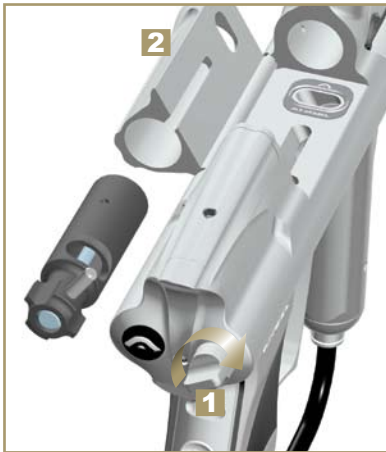

Velocity adjustment

Decreasing velocity

The velocity adjusting screw is located on the lower portion of the fore grip **1**.

To decrease the velocity, insert a 3mm Allen Key **2** into the velocity adjusting screw and rotate clockwise.

Increasing velocity

To increase the velocity insert a 3mm Allen key **2** into the velocity adjusting screw and rotate counter clockwise.

NOTE: When reducing velocity allow at least four shots for the complete system to re calibrate to the new regulated pressure.

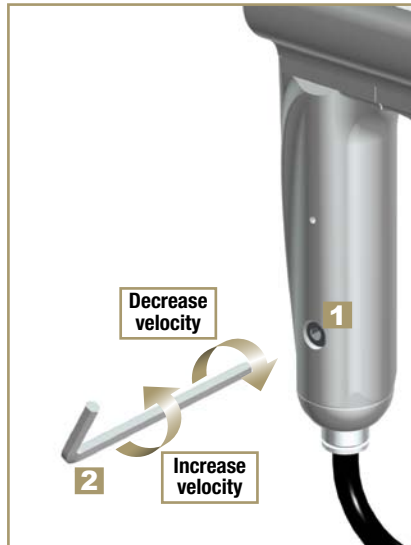

ANGEL ¹



⚠ WARNING

ADHERE STRICTLY TO THESE AND ALL OTHER SAFETY INSTRUCTIONS AND GUIDELINES

- Ensure a barrel blocking device is fitted to the ANGEL.
- Ensure the hopper is removed from the ANGEL.
- Ensure that there are no paintballs in the ANGEL.
- Ensure the ANGEL is switched off via the navigation switch on the rear of the grip frame prior to fitting your first stage regulator.
- Paintball industry standard eye/face/ear and head protection designed specifically to stop paintballs and meeting ASTM standard F1776 (USA) or CE standard (Europe) must be worn by user and any person within range.
- Always follow instructions, warnings and guidelines given with any first stage regulator you use with the ANGEL.
- Use compressed air/nitrogen gas only DO NOT USE CO2.
- Only use a paintball regulator that has been designed for air or nitrogen gas.
- Do not exceed 850 psi (58bar) input pressure to the ANGEL.
- Take suitable precautions when using sharp cutting instruments.
- The Macro Line hose must be cut back cleanly and square prior to attachment or re-attachment to ensure secure fitment.
- SHOULD YOU BE UNSURE AT ANY STAGE YOU MUST SEEK EXPERT ADVICE.



⚠ WARNING**ADHERE STRICTLY TO THESE
AND ALL OTHER SAFETY
INSTRUCTIONS AND GUIDELINES**

- Ensure a barrel blocking device is fitted to the ANGEL.
- Ensure the hopper is removed from the ANGEL.
- Ensure that there are no paintballs in the ANGEL.
- SHOULD YOU BE UNSURE AT ANY STAGE YOU MUST SEEK EXPERT ADVICE.

IMPORTANT NOTE

At any point when accessing the OLED menu options - pulling the trigger will return you to the SAFE screen.

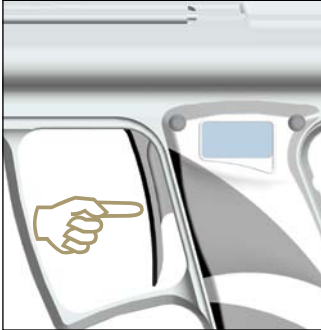
**OLED menu**

Once you have accessed the Status menu the Angel automatically reverts to SAFE

Status

The **Status** menu allows you to select between **Live/Safe**, the **Information** display screen and the **Parameters** setting.

- To access the **Status** menu press and hold the navigation switch up or down for 1.5 seconds.
- Once in the **Status** menu using the navigation switch scroll up or down to choose between **Live/Safe**, **Information** and **Parameters**.
- Pressing the navigation switch inwards will select the highlighted function.

Information

The **Information** screen will display all the relevant information relating to the electronic settings of your Angel.

- With the Angel on and Live push the navigation switch up or down for 1.5 seconds.
- The Angel will be in the **Status** menu.
- Use the navigation switch to scroll through the **Status** menu settings till **Information** is highlighted.
- Push the navigation switch inwards to select the **Information** menu.
- The following information will be displayed on the OLED. Scroll up or down using the navigation switch to view this information.

Status
Software version
Mode
Soft break-out setting
Hard break-out setting
Soft ramp setting
Hard ramp setting
Dwell time
MROF eyes on limit
MROF eyes off limit
De bounce level
Loader speed level
Shot % filtering
Anti Bolt Stick
Angel eyes on/off
Game timer set
Alarm time set
Total shots fired since reset
Battery voltage

Parameters

The Angel's settings can be easily adjusted from the **Parameters** menu.

- With the Angel on and Live push and hold the navigation switch up or down for 1.5 seconds.
- The Angel will be in the Status menu.
- Use the navigation switch to scroll through the Status menu settings till **Parameters** is highlighted.
- Push the navigation switch inwards to select the **Parameters** menu.

The following functions are all accessed via the navigation switch and can all be accessed and adjusted from the Parameters display.

Modes
Valve Dwell
De-bounce
Loader speed
MROF eyes ON
MROF eyes OFF
Breakout
Ramp feature
Shot Filter
ABS
Game Time Set
Alarm Time Set

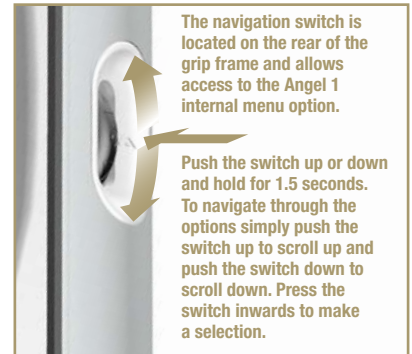

The navigation switch is located on the rear of the grip frame and allows access to the Angel 1 internal menu option.

Push the switch up or down and hold for 1.5 seconds. To navigate through the options simply push the switch up to scroll up and push the switch down to scroll down. Press the switch inwards to make a selection.

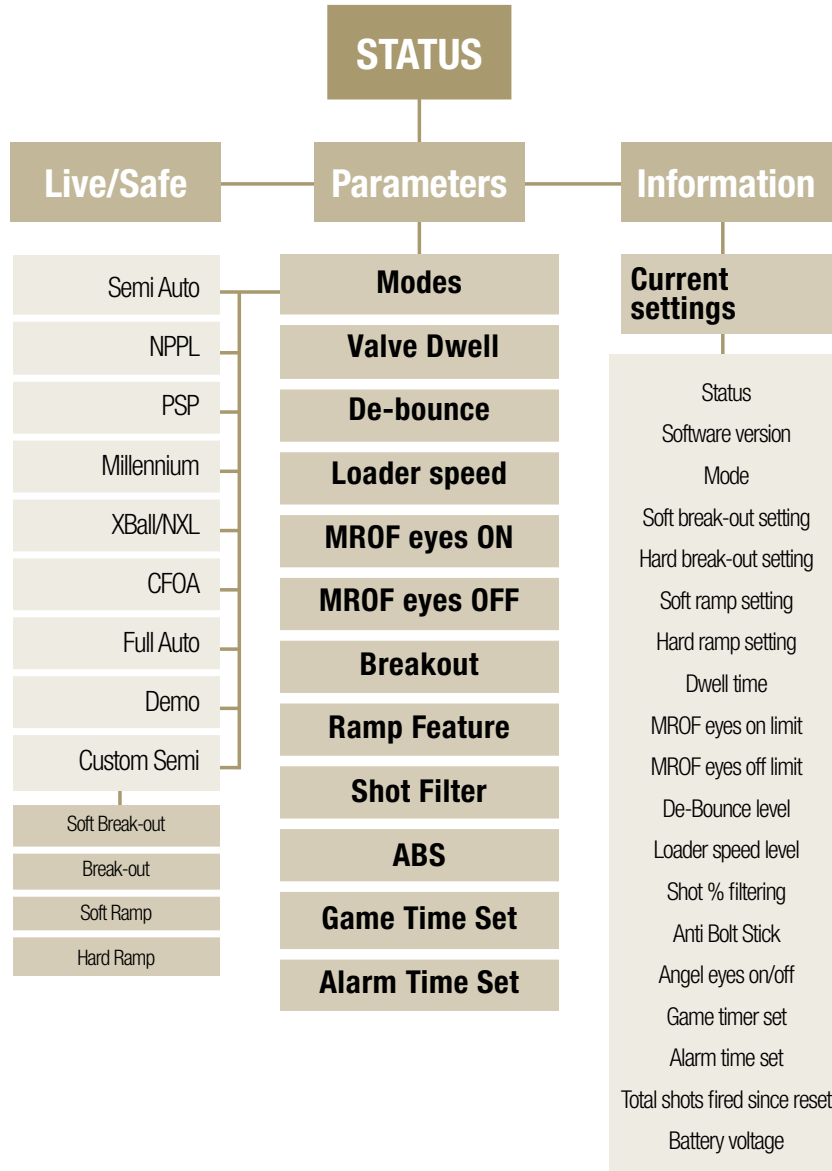

⚠ WARNING

ADHERE STRICTLY TO THESE AND ALL OTHER SAFETY INSTRUCTIONS AND GUIDELINES

- Ensure a barrel blocking device is fitted to the ANGEL.
- Ensure the hopper is removed from the ANGEL.
- Ensure that there are no paintballs in the ANGEL.
- SHOULD YOU BE UNSURE AT ANY STAGE YOU MUST SEEK EXPERT ADVICE.

IMPORTANT NOTE:

Tournament lock

To comply with some Tournament rules some of the Angel's features are required to be locked down so that they cannot be adjusted on the field of play.

For more details see page 16.

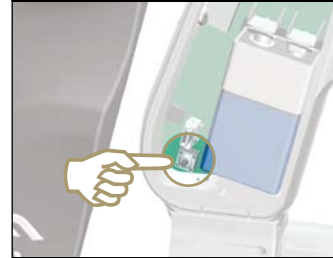

! WARNING**ADHERE STRICTLY TO THESE
AND ALL OTHER SAFETY
INSTRUCTIONS AND GUIDELINES**

- Ensure a barrel blocking device is fitted to the ANGEL.
- Ensure the hopper is removed from the ANGEL.
- Ensure that there are no paintballs in the ANGEL.
- SHOULD YOU BE UNSURE AT ANY STAGE YOU MUST SEEK EXPERT ADVICE.

MODE OPTIONS	Page
Semi Auto	10
NPPL	10
PSP	10
Millennium	10
XBall/NXL	10
CFOA	11
Full Auto	11
Demo	11
Custom Semi	11
Break-out	11
Soft Break-out	11
Hard Break-out	11
Ramp	12

MODES**Modes**

- Ensure that the Angel is switched on.
 - Ensure that you are not activating the trigger.
 - Push and hold the navigation switch UP or DOWN for 1.5 seconds.
 - The Status menu will be displayed.
 - Push the navigation button up to highlight the **Parameters** menu.
 - Push the navigation switch in to select the **Parameters** menu.
 - From the **Parameters** menu select the **Mode** feature by pushing the navigation switch inward.
 - Scroll up or down through the **Mode** options by pushing the navigation switch up or down.
 - Once the desired **Mode** setting has been reached press the navigation switch inwards to save the new setting.
 - A **Saved Mode** message will be displayed.
- The **Parameters** menu will be displayed.

Semi Auto

The Angel eyes will default to on whenever the Angel is made live via the navigation switch.

With the eyes activated the Angel will only fire when a paintball is present and has been detected by the Angel eyes.

With the eyes activated the MROF that the Angel will fire at is limited by the MROF eyes on level.

With the eyes turned off the MROF that the Angel will fire at is limited by the MROF eyes off level.

The Angel will fire 1 shot for each pull of the trigger.

Break-out and Ramp settings do not function in this Mode.

NPPL

The Angel eyes will default to on whenever the Angel is made live via the navigation switch.

With the eyes activated the Angel will only fire when a paintball is present and has been detected by the Angel eyes.

With the eyes activated the MROF that the Angel will fire at is limited by the MROF eyes on level.

With the eyes turned off the MROF that the Angel will fire at is limited by the MROF eyes off level.

The Angel will fire 1 shot for each pull of the trigger.

Break-out and Ramp settings do not function in this Mode.

PSP

The Angel eyes will default to on whenever the Angel is made live via the navigation switch.

With the eyes activated the Angel will only fire when a paintball is present and has been detected by the Angel eyes.

The first 3 shots will be fired in semi automatic.

On the 4th shot the Angel will ramp to a pre set MROF set at 15.4 balls per second, provided that the user maintains trigger pulls at a rate of or above 5 balls per second.

If the user stops firing for more than 1 second the initial 3 shots in semi automatic must be re initiated.

Millennium

The Angel eyes will default to on whenever the Angel is made live via the navigation switch.

With the eyes activated the Angel will only fire when a paintball is present and has been detected by the Angel eyes.

The rate of fire will be capped at 15 shots per sec.

Ramping of shots is allowed once 8 BPS is achieved the Angel may ramp up to 15 BPS only if 8 BPS or greater is maintained. Once the trigger is released only 1 additional shot may be discharged.

Additional break-out and ramp settings do not function in this Mode.

X-Ball/NXL

The Angel eyes will default to on whenever the Angel is made live via the navigation switch.

With the eyes activated the Angel will only fire when a paintball is present and has been detected by the Angel eyes.

The first 3 shots will be fired in semi automatic.

On the 4th shot if the trigger is pulled and held the Angel will fire fully automatic up to a pre set maximum MROF set at 15.4 balls per second.

The Angel will stop firing as soon as the trigger is released.

If the user stops firing for more than 1 second the initial 3 shots in semi automatic must be re initiated.

CFOA

The Angel eyes will default to on whenever the Angel is made live via the navigation switch.

With the eyes activated the Angel will only fire when a paintball is present and has been detected by the Angel eyes.

The first 3 shots will be fired in semi automatic.

On the 4th shot the Angel will ramp to a pre set MROF set at 15.4 balls per second, provided that the user maintains trigger pulls at a rate at or above 5 balls per second.

If the user stops firing for more than 1 second the initial 3 shots in semi automatic must be re initiated.

Full Auto

The Angel eyes will default to on whenever the Angel is made live via the navigation switch.

With the eyes activated the Angel will only fire when a paintball is present and has been detected by the Angel eyes.

The Angel will fire at a capped maximum rate of 15 balls per second with the Angel eyes activated.

With the angel eyes deactivated the Angel will fire at a capped maximum rate of 15 balls per second.

It is possible to lower the MROF with both eyes on and eyes off in this mode but you will not be permitted to raise them above the 15 bps cap.

Demo

This is a dry firing mode for firing the Angel when on display and is designed to demonstrate the rate of fire achievable. It should only be used for demonstration purposes, as the Angel eyes feature is reverse functioned so that it can not fire should a paintball be detected.

Custom Semi

The Angel eyes will default to on whenever the Angel is made live via the navigation switch.

With the eyes activated the Angel will only fire when a paintball is present and has been detected by the Angel eyes.

With the eyes activated the MROF that the Angel will fire at is limited by the MROF eyes on level.

With the eyes turned off the MROF that the Angel will fire at is limited by the MROF eyes off level.

The Angel will fire 1 shot for each pull of the trigger.

Break-out and Ramp settings can be used individually or in combination in this Mode.

Break-out

There are 2 break-out modes that can only be used when the Angel is in custom semi mode.

Soft break out

Once the soft break out feature has been selected from the custom modes screen and the Angel is on and live it will fire as if it were in normal semi auto mode until the break-out mode is activated. To activate the break-out feature press the navigation switch inwards, the alarm will momentarily sound to indicate that the break-out mode has been initiated. In order for the Angel to start firing in the break-out mode once it has been initiated a rate of trigger pulls higher than 4 per second must be reached and maintained within the time period that the break-out mode is active. The duration of the time period that the break-out mode is active can be adjusted. The range for this adjustment is 1 – 20 seconds. If the rate of trigger pulls at any point once the break-out mode has been initiated fall below 4 per second or should the trigger be pulled and held in for 2 seconds or the time period of the break-out elapses the break-out mode will revert to the previously selected mode.

Hard break-out

Once the hard break out feature has been selected from the custom modes screen and the Angel is on and live it will fire as if it were in normal semi auto mode until the break-out mode is activated.

⚠ WARNING

ADHERE STRICTLY TO THESE AND ALL OTHER SAFETY INSTRUCTIONS AND GUIDELINES

- Ensure a barrel blocking device is fitted to the ANGEL.
- Ensure the hopper is removed from the ANGEL.
- Ensure that there are no paintballs in the ANGEL.
- SHOULD YOU BE UNSURE AT ANY STAGE YOU MUST SEEK EXPERT ADVICE.

⚠ WARNING**ADHERE STRICTLY TO THESE
AND ALL OTHER SAFETY
INSTRUCTIONS AND GUIDELINES**

- Ensure a barrel blocking device is fitted to the ANGEL.
- Ensure the hopper is removed from the ANGEL.
- Ensure that there are no paintballs in the ANGEL.
- SHOULD YOU BE UNSURE AT ANY STAGE YOU MUST SEEK EXPERT ADVICE.

MODES

To activate the break-out feature press the navigation switch inwards, the alarm will momentarily sound to indicate that the break-out mode has been initiated. In order for the Angel to start firing in the break-out mode once it has been initiated the trigger must be pulled and held in within the time period that the break-out mode is active. The duration of the time period that the break-out mode is active can be adjusted. The range for this adjustment is 1 – 20 seconds. If the trigger is released at any point once the break-out mode has been initiated or the time period of the break-out elapses the break-out mode will revert to the previously selected mode.

Ramp

There are 2 Ramp modes that can only be used when the Angel is in custom semi mode, Soft ramp and Hard ramp.

There are 3 Parameters that can be adjusted to custom tune the ramp modes.

Start delay: This is the number of shots fired before the ramp mode starts. The range for the start delay is 1– 20 shots.

Kick in point: This sets the minimum number of trigger pulls per second that must be reached in order for the software to add shots. The range for the start delay is 1 – 20 trigger pulls per second.

Drop out point: This sets the minimum number of trigger pulls per second that must be maintained in order for the software to add shots. The range for the drop out point is 1 - 20 trigger pulls per seconds. Should the number of trigger pulls drop below this rate for more than 1 second the software will no longer add shots until the kick in point has been re-achieved.

To enable any of the ramping features it must be selected from the custom modes menu.

**Parameters -
Valve dwell - De-Bounce****Valve dwell**

Dwell controls the valve opening time. Longer dwell uses more gas and generates pressure variables. Shorter dwell uses less gas and reduces noise but is less tolerant of poor quality paint and can result in weak shots. The range of adjustment that is available is from 6 milliseconds to 15 milliseconds in 0.5 millisecond increments.

***Important Note:**
Internal lock button must be used to turn Dwell options on or off.*

- Ensure that the Angel is switched on
- Ensure that you are not activating the trigger
- Push and hold the navigation switch UP or DOWN for 1.5 seconds
- The **Status** menu will be displayed
- Push the navigation button up to highlight the **Parameters** menu
- Push the navigation switch in to select the Parameters menu
- From the **Parameters** menu select the **Dwell** feature by pushing the navigation switch inwards.
- Scroll up or down through the dwell settings by pushing the navigation switch up or down.
- Once the desired setting has been reached press the navigation switch inwards to save the new setting.
- A **Saved Dwell** message will be displayed. The **Parameters** menu will be displayed.

De-Bounce

This is the length of time that the trigger has to be pulled for it to be accepted by the electronics as a valid trigger activation.

There are 20 levels of adjustment 1 being the least sensitive 20 the most sensitive adjustment.

- Ensure that the Angel is switched on.
- Ensure that you are not activating the trigger.
- Push and hold the navigation switch UP or DOWN for 1.5 seconds.
- The **Status** menu will be displayed.
- Push the navigation button up to highlight the **Parameters** menu.

Parameters - Loader speed delay - MROF eyes on/off

- Push the navigation switch in to select the **Parameters** menu.
- From the Parameters menu select the **De-Bounce** feature by pushing the navigation switch inward.
- Scroll up or down through the **De-Bounce** settings by pushing the navigation switch up or down.
- Once the desired setting is reached press the navigation switch inwards to save the new setting.

A **Saved De-Bounce** message will be displayed.

The Parameters menu will be displayed.

Loader speed delay

This allows you to select the correct Angel eye settings for the type of loader that you are using. Once you have selected the correct setting the Angel eyes program will intelligently adjust itself to the variable speeds of your loader.

1- 4 = 9v agitator type loaders

5 – 8 = 12- 18v agitator type loaders

9 – 12 force fed type loaders

13-16 only very fast modified force fed loaders

- Ensure that your loader is at its maximum performance and reliability otherwise you may encounter problems related to the loader.
- Selection of a loader speed setting that is too high may result in ball breakages.
- Ensure that the Angel is switched on.
- Ensure that you are not activating the trigger.
- Push and hold the navigation switch UP or DOWN for 1.5 seconds.
- The **Status** menu will be displayed.
- Push the navigation button up to highlight the **Parameters** menu.
- Push the navigation switch in to select the **Parameters** menu.
- From the **Parameters** menu select the **Loader Speed** feature by pushing the navigation switch inward.
- Scroll up or down through the loader speed settings by pushing the navigation switch up or down.

Once the desired setting has been reached press the navigation switch inwards to save the new setting.

A **Saved loader speed** message will be displayed.

The **Parameters** menu will be displayed.

MROF eyes on

This allows the user to set the Maximum Rate Of Fire whilst the Angel eyes are on. There are 20 levels of adjustment ranging from 10 to unlimited balls per second.

- Ensure that the Angel is switched on.
- Ensure that you are not activating the trigger.
- Push and hold the navigation switch UP or DOWN for 1.5 seconds.
- The **Status** menu will be displayed.
- Push the navigation button up to highlight the **Parameters** menu.
- Push the navigation switch in to select the **Parameters** menu.
- From the **Parameters** menu select the **MROF eyes on** feature by pushing the navigation switch inwards.
- Scroll up or down through the **MROF eyes on** settings by pushing the navigation switch up or down.
- Once the desired setting has been reached press the navigation switch inwards to save new setting.

A **Saved MROF eyes on** message will be displayed.

The **Parameters** menu will be displayed.

MROF eyes off

This allows the user to set the Maximum Rate Of Fire whilst the Angel eyes are off. There are 20 levels of adjustment ranging from 10 to unlimited balls per second.

- Ensure that the Angel is switched on.
- Ensure that you are not activating the trigger.
- Push and hold the navigation switch UP or DOWN for 1.5 seconds.
- The **Status** menu will be displayed.
- Push the navigation button up to highlight the **Parameters** menu.
- Push the navigation switch in to select the **Parameters** menu.
- From the Parameters menu select the **MROF eyes off** feature by pushing the navigation switch inwards.
- Scroll up or down through the **MROF eyes off** settings by pushing the navigation switch up or down.

ANGEL 1

13

⚠ WARNING

ADHERE STRICTLY TO THESE AND ALL OTHER SAFETY INSTRUCTIONS AND GUIDELINES

- Ensure a barrel blocking device is fitted to the ANGEL.
- Ensure the hopper is removed from the ANGEL.
- Ensure that there are no paintballs in the ANGEL.
- SHOULD YOU BE UNSURE AT ANY STAGE YOU MUST SEEK EXPERT ADVICE.

The Angels default values are

Mode – semi

Soft break-out settings : seconds - **10**

Hard break-out settings: seconds - **10**

Soft ramp settings: start delay (shots) - **4** / kick in (bps) - **5** / Drop out (bps) - **4**

Hard ramp settings: start delay (shots) - **4** / kick in (bps) - **5** / Drop out (bps) - **4**

Dwell time (m/secs) - **11**

MROF eyes on limit – **unlimited**

MROF eyes off limit – **15bps**

De-Bounce (level) - **10**

Loader speed (level) - **9**

Angel eyes – **ON**

Game time set (mins/ Secs) – **7:10**

Alarm time set (mins/secs) – **6:00**

! WARNING**ADHERE STRICTLY TO THESE AND ALL OTHER SAFETY INSTRUCTIONS AND GUIDELINES**

- Ensure a barrel blocking device is fitted to the ANGEL.
- Ensure the hopper is removed from the ANGEL.
- Ensure that there are no paintballs in the ANGEL.
- SHOULD YOU BE UNSURE AT ANY STAGE YOU MUST SEEK EXPERT ADVICE.

Parameters - Breakout - Ramp - Shot % Filtering

- Once the desired setting has been reached press the navigation switch inwards to save the new setting.

A **Saved MROF eyes off** message will be displayed.

The **Parameters** menu will be displayed.

BREAKOUT

This allows the user to select between a soft and hard breakout mode, once the hard or soft option has been selected the duration that the breakout will be active for can then be selected. The length of the breakout mode duration can be set from 1 to 20 seconds.

- Ensure that the Angel is switched on.
- Ensure that you are not activating the trigger.
- Push and hold the navigation switch UP or DOWN for 1.5 seconds.
- The **Status** menu will be displayed.
- Push the navigation button up to highlight the **Parameters** menu.
- Push the navigation switch in to select the **Parameters** menu.
- From the **Parameters** menu select the **Breakout** feature by pushing the navigation switch inwards.
- Select **Soft** or **Hard Breakout** option using the navigation switch by pressing it inwards to confirm the desired option.
- Select the duration that you wish the breakout to be active for by using the navigation switch to scroll between the values of 1 and 20 seconds, press the navigation button inwards to confirm your desired settings.

A **Saved Soft/Hard Breakout** message is displayed.

The **Breakout** menu will be displayed.

Ramp

This allows the user to select 2 levels of ramp mode. Soft Ramp and Hard Ramp once the level of Ramp has been selected the user can then customize the ramp mode by selecting the start delay (number of shots to be fired before the ramp mode activates adjustable between 1 and 20 shots), kick in BPS (number of trigger pulls per second that has to be reached to get the ramp mode to start, adjustable between 4 and 16 shots), and the drop out BPS (minimum number of trigger pulls that must be maintained in order to keep the Angel in ramp mode,

adjustable between 4 and 16 shots)

- Ensure that the Angel is switched on.
- Ensure that you are not activating the trigger.
- Push and hold the navigation switch UP or DOWN for 1.5 seconds.
- The **Status** menu will be displayed.
- Push the navigation button up to highlight the **Parameters** menu.
- Push the navigation switch in to select the **Parameters** menu.
- From the **Parameters** menu select the **Ramp** feature by pushing the navigation switch inwards.
- Select **Soft** or **Hard Ramp** option using the navigation switch by pressing it inwards to confirm the desired option.
- You can then select to adjust **Start Delay, Kick in BPS** and **Drop out BPS** by pressing the navigation switch inwards.

A **Saved Start Delay, Kick in BPS** and **Drop out BPS** message will be displayed.

The **Soft** or **Hard Ramp** menu will be displayed.

Shot % filtering

This allows the adjustment of the point within the current firing cycle that a new buffered shot will be accepted. The Shot % filter is adjustable from 1 to 20 levels.

Level 1 turns the shot filtering off which allows the additional shot to be registered at the earliest point after the eyes have detected a ball and the trigger has provided a viable fire command. Levels 2 through to 20 sets the % of the firing cycle that must have been completed before the additional shot may be allowed from 10% of the cycle increasing in 5% increments up to a maximum of 100% of the cycle.

- Ensure that the Angel is switched on.
- Ensure that you are not activating the trigger.
- Push and hold the navigation switch UP or DOWN for 1.5 seconds.
- The **Status** menu will be displayed.
- Push the navigation button up to highlight the **Parameters** menu.
- Push the navigation switch in to select the **Parameters** menu.
- From the **Parameters** menu select the

Parameters - Anti bolt stick

Shot % Filtering feature by pushing the navigation switch inward.

- Scroll up or down through the **Shot % Filtering** settings by pushing the navigation switch up or down.
- Once the desired setting has been reached press the navigation switch inwards to save the new setting.

A **Saved Shot % Filtering** message will be displayed.

The Parameters menu will be displayed.

Anti Bolt Stick

First shot drop off can occur when the valve or ram incurs static friction after a period of inactivity, this results in the first shots fired after this inactivity being lower in velocity because the seals need to break free from the forces of the static friction.

Anti Bolt stick programming allows the dwell time to be increased for the first 2 shots if the Angel had been inactive for 15 seconds to overcome static friction. There are 20 levels of ABS adjustment ranging from 0.25 milliseconds to 5 milliseconds.

- Ensure that the Angel is switched on.
- Ensure that you are not activating the trigger.
- Push and hold the navigation switch UP or DOWN for 1.5 seconds.
- The **Status** menu will be displayed.
- Push the navigation button up to highlight the **Parameters** menu.
- Push the navigation switch in to select the **Parameters** menu.
- From the **Parameters** menu select the **Anti Bolt Stick** feature by pushing the navigation switch inwards.
- Scroll up or down through the **Anti Bolt Stick** settings by pushing the navigation switch up or down.
- Once the desired setting has been reached press the navigation switch inwards to save the new setting.

A **Saved Anti Bolt Stick** message will be displayed

The **Parameters** menu will be displayed.

Software version - Factory reset

Software version

The software version is displayed on the information page.

- With the Angel on and **Live** push the navigation switch up or down for 1.5 seconds.
- The Angel will be in the **Status** menu .
- Use the navigation switch to scroll through the Status menu settings till **Information** is highlighted.

Push the navigation switch inward to select the **Information** menu.

Factory reset

The default factory settings can be restored if required at any time.

- Press the internal button located on the circuit board inside the grip frame.
- The screen will display the internal options menu
- Using the navigation switch scroll up or down to select the reset function.
- Press the navigation switch inward to initiate the reset function.
- You will be asked to confirm that you wish to continue with this action. Press the navigation button inward to confirm this is correct.
- A reset message will be displayed on the screen confirming that the default settings have successfully been restored.

ANGEL 1

15

! WARNING

ADHERE STRICTLY TO THESE AND ALL OTHER SAFETY INSTRUCTIONS AND GUIDELINES

- Ensure a barrel blocking device is fitted to the ANGEL.
- Ensure the hopper is removed from the ANGEL.
- Ensure that there are no paintballs in the ANGEL.
- SHOULD YOU BE UNSURE AT ANY STAGE YOU MUST SEEK EXPERT ADVICE.

! WARNING**ADHERE STRICTLY TO THESE
AND ALL OTHER SAFETY
INSTRUCTIONS AND GUIDELINES**

- Ensure a barrel blocking device is fitted to the ANGEL.
- Ensure the hopper is removed from the ANGEL.
- Ensure that there are no paintballs in the ANGEL.
- SHOULD YOU BE UNSURE AT ANY STAGE YOU MUST SEEK EXPERT ADVICE.

Game timer alarm

Game timer/alarm

This is a fully interactive game timer with count down alarm that will allow you and your team to play in unison. The timer and alarm can be set in either 1 second or 1 minute increments from 0 to 60 minutes. Once the alarm and timer are set they will be activated by the first trigger pull after making the Angel live and selecting the timer function.

- Ensure that the Angel is switched on.
 - Ensure that you are not activating the trigger.
 - Push and hold the navigation switch UP or DOWN for 1.5 seconds.
 - The **Status** menu will be displayed.
 - Push the navigation button up to highlight the **Parameters** menu.
 - Push the navigation switch in to select the **Parameters** men.
 - From the **Parameters** menu select the **Game or alarm timer** feature depending on what you wish to adjust by pushing the navigation switch inwards.
 - Using the navigation switch scroll up or down to highlight **Change timer**.
 - Push the navigation button to select **Change timer**.
 - Using the navigation switch scroll up or down to select the first digit required.
 - Push the navigation button inward to store the first digit.
 - Using the navigation switch scroll up or down to select the second digit required.
 - Push the navigation button inward to store the second digit.
 - Using the navigation switch scroll up or down to select the third digit required.
 - Push the navigation button inward to store the third digit.
 - Using the navigation switch scroll up or down to select the fourth digit required.
 - Push the navigation button inward to store the fourth digit.
 - Push the navigation switch inward to **Save time**
- Saved game timer/game alarm** message displayed on screen.

Tournament lock

Tournament lock

To comply with some Tournament rules some of the Angels features are required to be locked down so that they can not be adjusted on the field of play.

- Press the internal button located on the circuit board inside the grip frame **1**.



- The screen will display the internal options menu.
- Using the navigation switch scroll up or down to highlight the **Tournament lock** function.
- Press the navigation switch inward to initiate the **Tournament lock features**.
- Using the navigation switch scroll up or down to highlight the **Lock** or **Unlock** feature as required.
- Press the navigation switch inward to enable or disable the **Tournament lock** function as required.
- You will be asked to confirm that you wish to continue with this action. Press the navigation button inward to confirm this is correct.
- A padlock icon will be displayed on the screen indicating the Status of the tournament lock.
- The following features are affected by the tournament lock.

Modes

MROF eyes on

MROF eyes off

Dwell

De-Bounce

Shot % filtering

Anti Bolt Stick

In order to adjust any of these features the tournament lock must be disabled.

General care and cleaning Left & right hand cut-aways

ANGEL 1

17

⚠ WARNING

ADHERE STRICTLY TO THESE AND ALL OTHER SAFETY INSTRUCTIONS AND GUIDELINES

- Ensure a barrel blocking device is fitted to the ANGEL.
- Ensure the hopper is removed from the ANGEL.
- Ensure that there are no paintballs in the ANGEL.
- Always remove the first stage regulator and release all residual gas pressure from the Angel before disassembly.
- The Angel can hold a small residual gas charge, typically two shots, with the first stage regulator removed. Always discharge the Angel in a safe direction to relieve this residual gas pressure.
- SHOULD YOU BE UNSURE AT ANY STAGE YOU MUST SEEK EXPERT ADVICE.



⚠ WARNING**ADHERE STRICTLY TO THESE
AND ALL OTHER SAFETY
INSTRUCTIONS AND GUIDELINES**

- Ensure a barrel blocking device is fitted to the ANGEL.
- Ensure the hopper is removed from the ANGEL.
- Ensure that there are no paintballs in the ANGEL.
- Always remove the first stage regulator and release all residual gas pressure from the Angel before disassembly.
- The Angel can hold a small residual gas charge, typically two shots, with the first stage regulator removed. Always discharge the Angel in a safe direction to relieve this residual gas pressure.
- SHOULD YOU BE UNSURE AT ANY STAGE YOU MUST SEEK EXPERT ADVICE.

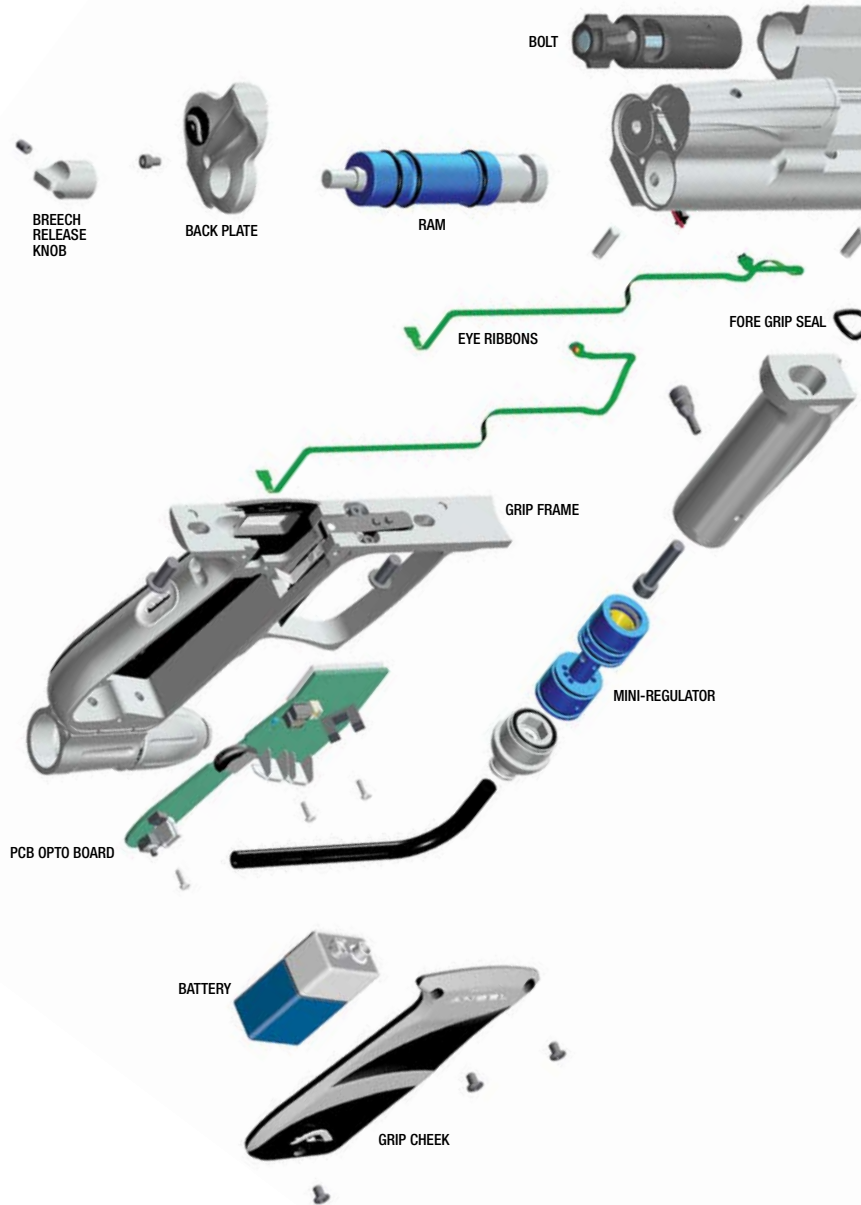
General assemblies

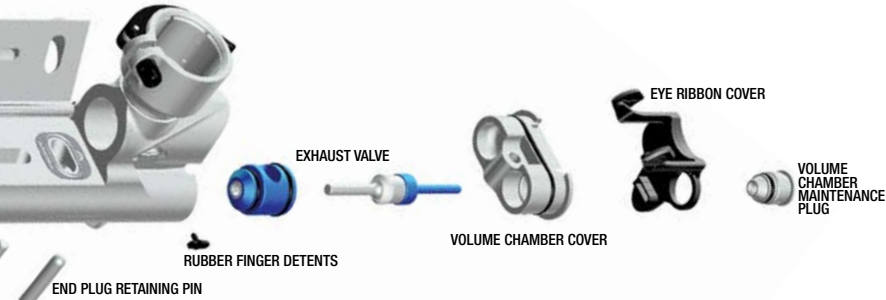

The ANGEL should only be cleaned externally using a synthetic oil moistened cloth. Under no circumstances should you use hydrocarbon based oils, as these will cause irrevocable damage to the internal seals, e.g.: WD40, Vaseline, Duck Oil, Engine oil, Plus Gas, 3in1. The suitable oil is Angel Love Juice Oil.

The ram shaft and internal parts that are accessible during disassembly and re-assembly should be lubricated with Angel Love Juice Extreme Grease. The frequency of lubrication should be every event or at least 8000 shots for oil lubrication and 20,000 shots for grease lubrication. The ANGEL should never be immersed into water otherwise damage may occur to the electronics. Ensure correct tools are used.

IMPORTANT NOTES:

- No solvents or abrasive cleaning products should be used. All external and internal accessible moving parts should be lubricated using light synthetic oil only.
- All threads on the Angel, except those for the Angel accessory mountings at the base of the grip frame (see below), are metric.

Angel accessory mountings use industry standard 10/32 UNF at centres 0.75" (20mm).

When inserting screws in to the bottom of the grip frame - the screw thread length must not exceed 0.375" (10mm) otherwise damage will occur to the electronics.

We recommend that you remove the right-hand cheek cover and battery when inserting these screws and ensure that the screws do not project into the circuit board cavity when fitting.

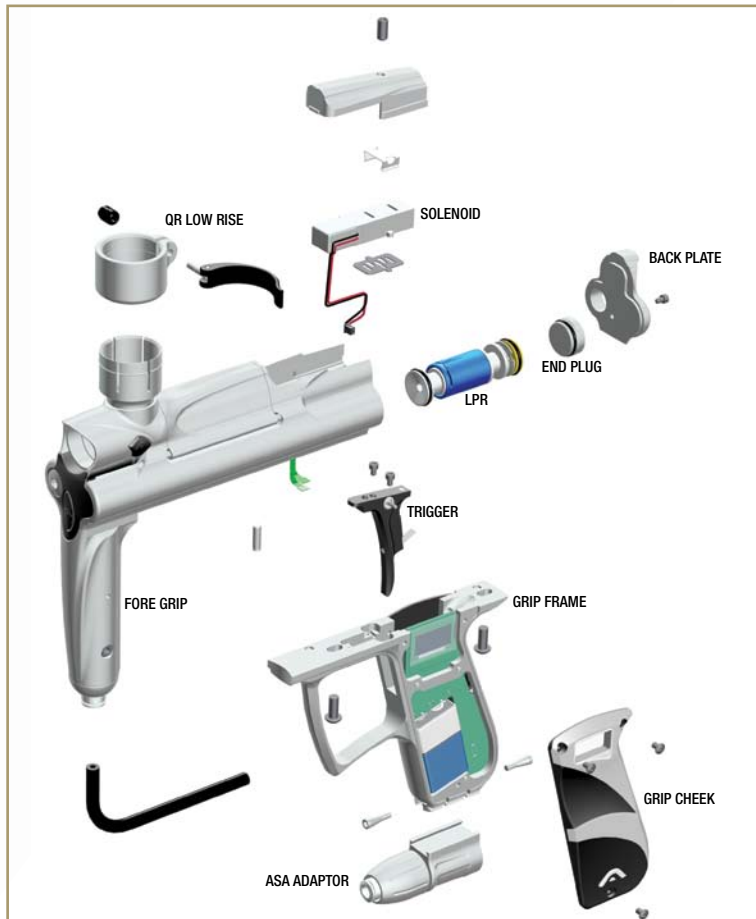

⚠ WARNING**ADHERE STRICTLY TO THESE AND ALL OTHER SAFETY INSTRUCTIONS AND GUIDELINES**

- Ensure a barrel blocking device is fitted to the ANGEL.
- Ensure the hopper is removed from the ANGEL.
- Ensure that there are no paintballs in the ANGEL.
- Always remove the first stage regulator and release all residual gas pressure from the Angel before disassembly.
- The Angel can hold a small residual gas charge, typically two shots, with the first stage regulator removed. Always discharge the Angel in a safe direction to relieve this residual gas pressure.
- SHOULD YOU BE UNSURE AT ANY STAGE YOU MUST SEEK EXPERT ADVICE.

In-line regulator service & assembly

The mini-regulator is a second stage regulator that is used to control the velocity and regulate the gas pressure. It can be deleted, but only if a suitable first stage regulator is used that incorporates a high flow and good regulation properties across the tank pressure range.

- Remove the macro line hose from the mini regulator by following the procedure and warnings given in PROPELLANT AIR/NITROGEN SUPPLY
- Remove the mini-regulator adjuster screw **1** taking care not to lose the small ball bearing.
- Remove the mini regulator end cap **2** by inserting a M4 Allen key into the macro line fitting **3** and rotating counter clockwise.
- Insert mini reg spool extraction tool **4** into the threaded hole in the bottom of the spool and gently extract the spool **5**.
- Remove the circlip **6** located in the spool using suitable circlip pliers.

- Invert the mini-regulator spool and tap it down firmly onto a smooth surface to shock the internals out of the mini-regulator body.
- Ensure the large piston **7**, Spring stack **8**, small piston **9**, and the ball bearing **10** are removed.
- Inspect the O rings **11** for damage and replace if necessary.
- Inspect the small piston **9** face seal for damage and replace the whole small piston if necessary.
- Inspect the large piston **7** and small piston **9** sealing faces for damage and replace as necessary.

Note: If replacement of the macro line hose connector is required remove the regulator end cap from the fore grip before attempting to replace the fitting. Failure to do so can result in damage to regulator end or the fore grip.

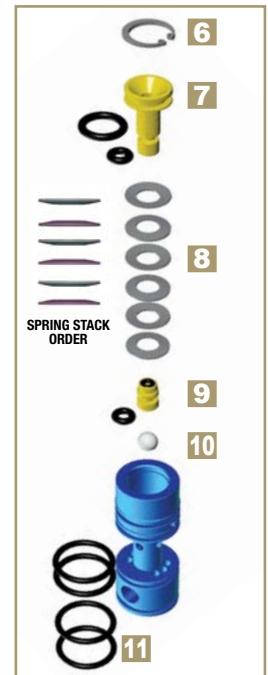
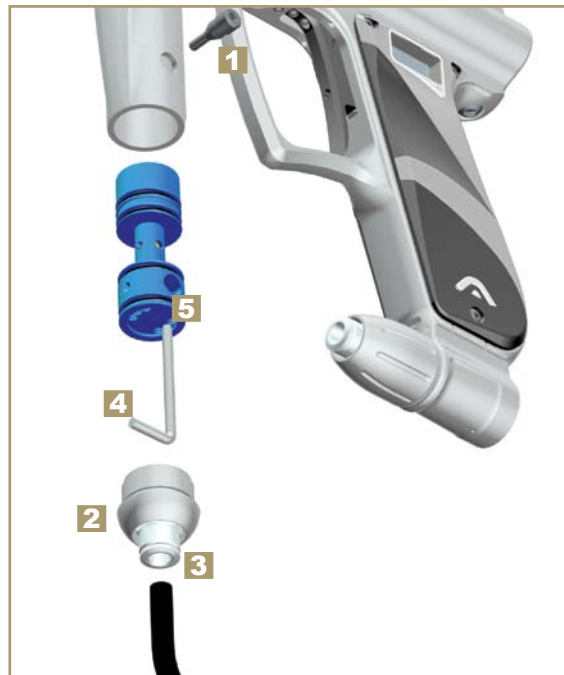

Rubber finger detent

ANGEL™ 1

21



To gain access to the rubber finger detents **1**, to carry out maintenance or to replace the rubber fingers.

- Remove Macroline from Fore Grip **2**.
- Remove Fore Grip Cap **3**.
- Remove Mini Reg **4**.
- Remove Fore Grip **5** – ensure that Fore Grip Seal **6** isn't lost (see page 20).
- Remove the volume chamber maintenance plug **7** with a 4mm Allen key.
- To remove the eye cover **8**, slide a blunt blade beneath the 'A icon' on the left side of the eye cover (ensuring you do not insert the blade too far) to lever out and retain the arm open. Repeat the same procedure on the right arm. Slide the cover towards the front and off the Angel ensuring the Rubber Finger Detents **1** are not lost.



Rubber detent orientation



⚠ WARNING

ADHERE STRICTLY TO THESE AND ALL OTHER SAFETY INSTRUCTIONS AND GUIDELINES

- Ensure a barrel blocking device is fitted to the ANGEL.
- Ensure the hopper is removed from the ANGEL.
- Ensure that there are no paintballs in the ANGEL.
- SHOULD YOU BE UNSURE AT ANY STAGE YOU MUST SEEK EXPERT ADVICE.

⚠ WARNING**ADHERE STRICTLY TO THESE AND ALL OTHER SAFETY INSTRUCTIONS AND GUIDELINES**

- Ensure a barrel blocking device is fitted to the ANGEL.
- Ensure the hopper is removed from the ANGEL.
- Ensure that there are no paintballs in the ANGEL.
- Always remove the first stage regulator and release all residual gas pressure from the Angel before disassembly.
- The Angel can hold a small residual gas charge, typically two shots, with the first stage regulator removed. Always discharge the Angel in a safe direction to relieve this residual gas pressure.
- **SHOULD YOU BE UNSURE AT ANY STAGE YOU MUST SEEK EXPERT ADVICE.**

Angel eyes servicing

The Angel uses a visible dual optical eye (break beam) system to detect when a ball is in position ready to fire.

The eyes are located under the eye ribbon cover **1**.

- Remove Macroline from Fore Grip **2**.
- Remove Fore Grip Cap **3**.
- Remove the mini reg spool **4** as per the in line regulator service instructions (see page 20).
- Remove the fore grip body internal retaining screw **5** using a 4mm Allen key and the fore grip itself **6**.
- Ensure that the fore grip body seal **7** is not lost.
- Remove the volume chamber maintenance plug **8** with a 4mm Allen key.
- To remove the eye cover **1**, slide a blunt blade beneath the 'A icon' on the left side of the eye cover (ensuring you do not insert the blade too far) to lever out and retain the arm open. Repeat the same procedure on the right arm. Slide the cover towards the front and off the Angel.



- Carefully extract each eye **9** from its location and clean the eye and location hole if required.

Important Notes for re assembly: The Angel eyes sensor MUST NOT be pulled out of the body by the ribbon cable; the sensor MUST be Pushed out using a suitable blunt pick from within the body.



Angel eyes removal

- Carefully extract the eyes from the body. See 'Angel eyes servicing' (page 22) opposite.

Then:

- Remove the right hand grip cheek cover **10** by removing the 3 retaining screws **11** using a metric 2mm Allen key.
- Unplug the solenoid plug **12** from the PCB.
- Remove the Angel eyes ribbon cable connectors **13** from the ZIFF socket on the PCB.
- Remove the Grip Frame **14** by removing the 2 retaining screws **15** using a 3mm Allen key.
- Carefully remove the Angel Eyes **9**.

Important Notes for re assembly:

Ensure no wires become trapped between the body and the grip frame during re assembly.

When reassembling the Angel Eyes, place the eyes back into their location holes then feed the ribbons into the channels on the front and underside of the body. Hold the eyes and Rubber Finger Detents in place with one hand and slide the cover on with the other.

NOTE: WHEN RECONNECTING THE EYE RIBBONS TO THE PCB THE SHORTER RIBBON CONNECTS TO TOP ZIFF SOCKET.

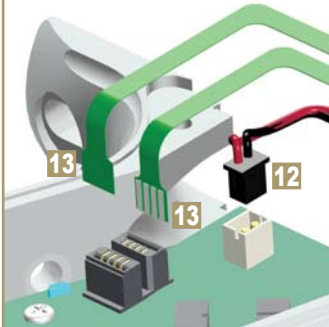

ANGEL 1

23

⚠ WARNING

ADHERE STRICTLY TO THESE AND ALL OTHER SAFETY INSTRUCTIONS AND GUIDELINES

- Ensure a barrel blocking device is fitted to the ANGEL.
- Ensure the hopper is removed from the ANGEL.
- Ensure that there are no paintballs in the ANGEL.
- Always remove the first stage regulator and release all residual gas pressure from the Angel before disassembly.
- The Angel can hold a small residual gas charge, typically two shots, with the first stage regulator removed. Always discharge the Angel in a safe direction to relieve this residual gas pressure.
- SHOULD YOU BE UNSURE AT ANY STAGE YOU MUST SEEK EXPERT ADVICE.

⚠ WARNING**ADHERE STRICTLY TO THESE AND ALL OTHER SAFETY INSTRUCTIONS AND GUIDELINES**

- Ensure a barrel blocking device is fitted to the ANGEL.
- Ensure the hopper is removed from the ANGEL.
- Ensure that there are no paintballs in the ANGEL.
- Always remove the first stage regulator and release all residual gas pressure from the Angel before disassembly.
- The Angel can hold a small residual gas charge, typically two shots, with the first stage regulator removed. Always discharge the Angel in a safe direction to relieve this residual gas pressure.
- SHOULD YOU BE UNSURE AT ANY STAGE YOU MUST SEEK EXPERT ADVICE.

LPR adjustment

The low pressure regulator controls the pneumatic cycle of the Angel and is located in the left hand chamber at the rear of the Angel body.

The pressure needs to be at approximately 65psi (4.5bar) output from an input pressure of 350psi from the second stage regulator.

LPR adjustment is achieved by the addition or removal of shims. Each shim equals approximately 2psi (0.14bar) we recommend the use of the optional service tools and lubrication of parts with LOVE JUICE extreme grease only.

- Ensure that the Angel is de-gassed and switched off.
- Remove the back plate **1** using a suitable 2mm Allen key.
- Remove the LPR chamber plug **2** using a suitable 4mm Allen key.
- Insert the optional pressure gauge adaptor into the hole that the chamber plug was removed from.
- Re gas the Angel and press the navigation switch to turn the Angel on.

⚠ WARNING

ADHERE STRICTLY TO THESE AND ALL OTHER SAFETY INSTRUCTIONS AND GUIDELINES

· THE ANGEL IS LIVE AND CAPABLE OF DISCHARGING.

- Fire 6 shots with NO paintballs present to stabilize the LPR pressure.

⚠ WARNING

ADHERE STRICTLY TO THESE AND ALL OTHER SAFETY INSTRUCTIONS AND GUIDELINES

- Always remove the first stage regulator and release all residual gas pressure from the Angel before disassembly.
- The Angel can hold a small residual gas charge, typically two shots, with the first stage regulator removed. Always discharge the Angel in a safe direction to relieve this residual gas pressure.

Note the pressure reading. Should the reading be too high or low proceed to the next stage.

Ensure that the Angel is de-gassed and switched off

- Remove the pressure gauge adaptor and insert the piston extracting **3** tool into the piston **4** and withdraw it slowly.
- Remove the 3 tri-active piston springs **5**.
- Add or subtract shims **6** as necessary, note that the number of shims may vary from the diagram shown.
- Replace the 3 tri active springs **5** in correct order onto the piston.
- Re insert the piston **4** ensuring that it is located correctly.
- Insert the optional pressure gauge adaptor into the hole that the end cap was removed from.
- Re gas the Angel and press the navigation switch to turn the Angel on.

⚠ WARNING

ADHERE STRICTLY TO THESE AND ALL OTHER SAFETY INSTRUCTIONS AND GUIDELINES

· THE ANGEL IS LIVE AND CAPABLE OF DISCHARGING.

- Verify the LPR pressure by following the procedure described above. Once the desired pressure has been achieved proceed to the next stage.

⚠ WARNING

ADHERE STRICTLY TO THESE AND ALL OTHER SAFETY INSTRUCTIONS AND GUIDELINES

- Always remove the first stage regulator and release all residual gas pressure from the Angel before disassembly.
- The Angel can hold a small residual gas charge, typically two shots, with the first stage regulator removed. Always discharge the Angel in a safe direction to relieve this residual gas pressure.

- Ensure the Angel is de-gassed and switched off.
- Remove the pressure gauge adaptor and replace the LPR chamber plug **2**.

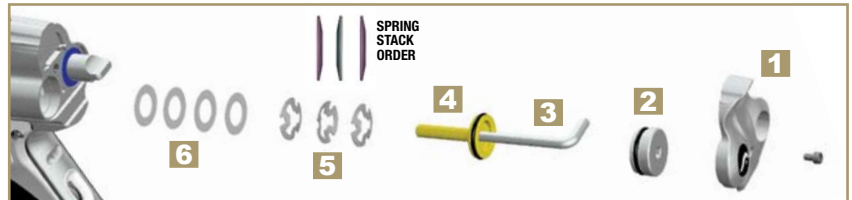

LPR assembly Removal & Replacement

- Remove the back plate **1** using a suitable 2mm Allen key.
- Remove the LPR chamber end plug **2** using a suitable 4mm Allen key.
- Remove the right hand grip cheek cover **3** by removing the 3 retaining screws using a 2mm Allen key.
- Remove the top plate retaining screw **4** and slide the top plate backwards to remove.
- Unplug the solenoid plug **5** from the PCB and carefully feed it through the guide hole in the Angel body. Ensure that the solenoid load spreader **6** does not cover the exhaust ports.
- Remove the Angel eyes ribbon cable connectors **7** from the ZIFF socket on the circuit board.

- Remove the 2 grip frame retaining screws **8** using a 3mm Allen key.
- Remove the LPR retaining pin **9**.
- Insert the LPR piston extracting tool **10** into the piston **11** and withdraw slowly.
- Remove the 3 tri active piston spring stack **12**.
- Remove the shims **13**.
- Remove the piston spacer **14**
- Using a suitable blunt pick, carefully withdraw the LPR body **15**.

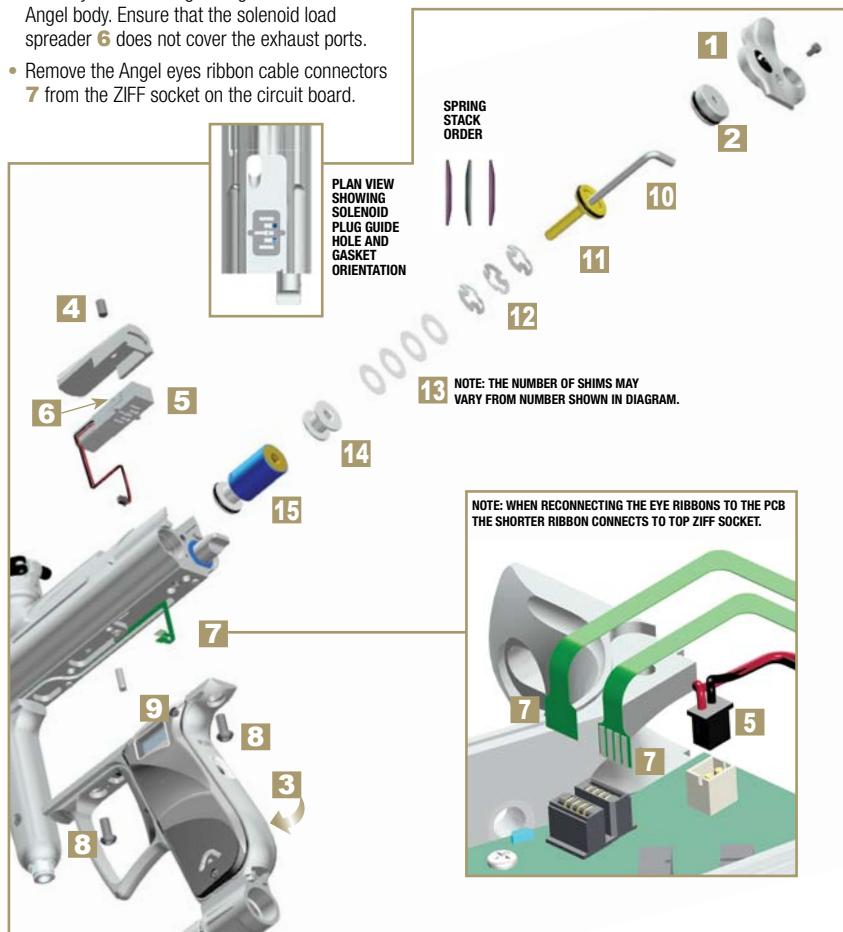

ANGEL 1

25

⚠ WARNING

ADHERE STRICTLY TO THESE AND ALL OTHER SAFETY INSTRUCTIONS AND GUIDELINES

- Ensure a barrel blocking device is fitted to the ANGEL.
- Ensure the hopper is removed from the ANGEL.
- Ensure that there are no paintballs in the ANGEL.
- Always remove the first stage regulator and release all residual gas pressure from the Angel before disassembly.
- The Angel can hold a small residual gas charge, typically two shots, with the first stage regulator removed. Always discharge the Angel in a safe direction to relieve this residual gas pressure.
- SHOULD YOU BE UNSURE AT ANY STAGE YOU MUST SEEK EXPERT ADVICE.

⚠ WARNING**ADHERE STRICTLY TO THESE
AND ALL OTHER SAFETY
INSTRUCTIONS AND GUIDELINES**

- Ensure a barrel blocking device is fitted to the ANGEL.
- Ensure the hopper is removed from the ANGEL.
- Ensure that there are no paintballs in the ANGEL.
- Always remove the first stage regulator and release all residual gas pressure from the Angel before disassembly.
- The Angel can hold a small residual gas charge, typically two shots, with the first stage regulator removed. Always discharge the Angel in a safe direction to relieve this residual gas pressure.
- SHOULD YOU BE UNSURE AT ANY STAGE YOU MUST SEEK EXPERT ADVICE.

LPR spool Removal**LPR spool replacement**

The LPR may be serviced once it has been removed by following the LPR assembly removal. The serviceable parts are the external O rings and the LPR spool.

- Remove the LPR piston **1**.
- Remove the LPR spring stack **2** noting the order.
- Remove the LPR shims **3**.

Note: the number of shims may vary from the shown diagram.

- Remove the piston spacer **4**.
- Remove the LPR spool retaining clip (circlip) **6** using a suitable blunt pick. You may need to rotate the circlip to align the groove in the LPR body **5** with the hole in the circlip **6**.
- Remove the LPR spool **7**.
- Discard LPR spool and replace with a new item.

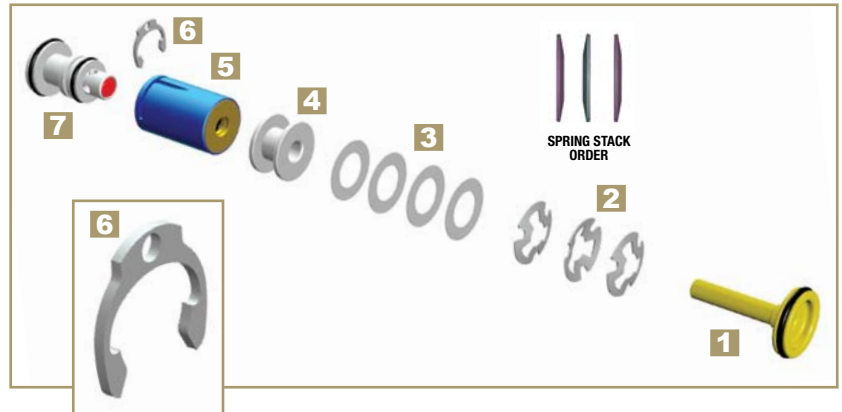

Exhaust valve guide removal

- Remove the mini reg spool **1** as per the in line regulator service instructions (see page 20).
- Remove the fore grip body internal retaining screw **2** using a 4mm Allen key and the fore grip itself **3**.
- Ensure that the fore grip body seal **4** is not lost.
- Extract shear pin **5** by inserting the M3 extraction tool (supplied) into the threaded end of the shear pin.
- Remove the volume chamber maintenance plug and eye ribbon cover **6** (see page 22).
- Remove the volume chamber plug **7** being careful not to damage the end plug seal.
- Remove the exhaust valve stem **8**.
- Remove the grip cheek cover **9** by removing the 3 retaining screws using a metric 2mm Allen key.
- Unplug the Angel eyes and solenoid plugs (see page 22) from the circuit board.
- Remove the 2 grip frame screws **10** holding the frame to the body using a suitable 3mm Allen key.
- Remove the grip frame **11** from the body.
- Pull out the exhaust valve guide retaining pin **12** located in the body using suitable grips.
- Using a suitable blunt hooked pick carefully retract the exhaust valve guide **13** by inserting the pick into the exhaust valve hole that the exhaust valve stem located into.
- Inspect and service parts as necessary.

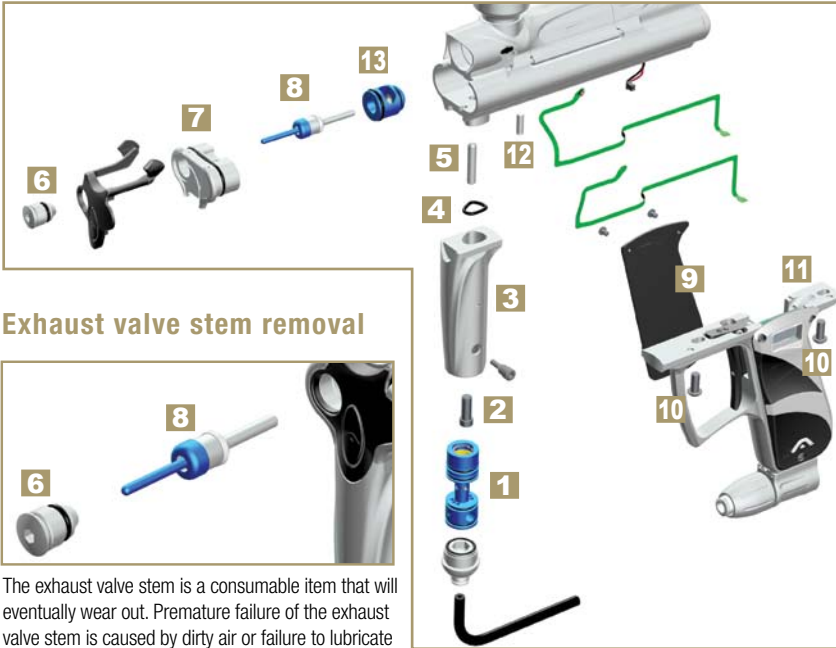

Exhaust valve stem removal

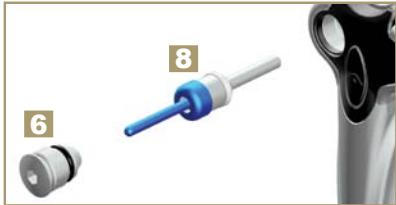

The exhaust valve stem is a consumable item that will eventually wear out. Premature failure of the exhaust valve stem is caused by dirty air or failure to lubricate it at service intervals, to replace the exhaust valve stem follow the procedures listed below.

- Remove the volume chamber valve maintenance plug **6**.
- Remove the valve stem assembly **8**.

Important notes for the re assembly of components.

- Ensure exhaust valve stem assembly is located in the exhaust body within the Angel.
- Ensure that the end cap is located correctly.

⚠ WARNING

ADHERE STRICTLY TO THESE AND ALL OTHER SAFETY INSTRUCTIONS AND GUIDELINES

- Ensure a barrel blocking device is fitted to the ANGEL.
- Ensure the hopper is removed from the ANGEL.
- Ensure that there are no paintballs in the ANGEL.
- Always remove the first stage regulator and release all residual gas pressure from the Angel before disassembly.
- The Angel can hold a small residual gas charge, typically two shots, with the first stage regulator removed. Always discharge the Angel in a safe direction to relieve this residual gas pressure.
- NEVER adjust your trigger so fine that accidental discharge can occur due to shock loads or vibration.
- SHOULD YOU BE UNSURE AT ANY STAGE YOU MUST SEEK EXPERT ADVICE.

⚠ WARNING**ADHERE STRICTLY TO THESE AND ALL OTHER SAFETY INSTRUCTIONS AND GUIDELINES**

- Ensure a barrel blocking device is fitted to the ANGEL.
- Ensure the hopper is removed from the ANGEL.
- Ensure that there are no paintballs in the ANGEL.
- Always remove the first stage regulator and release all residual gas pressure from the Angel before disassembly.
- The Angel can hold a small residual gas charge, typically two shots, with the first stage regulator removed. Always discharge the Angel in a safe direction to relieve this residual gas pressure.
- SHOULD YOU BE UNSURE AT ANY STAGE YOU MUST SEEK EXPERT ADVICE.

Ram removal

- Ensure the ANGEL is de-gassed and switched OFF or the ANGEL is in SAFE mode.
- Rotate the breech release knob **1** clockwise until it stops (see page 7).
- Swing out the Rotor Breech block **2** so that the bolt is exposed.

NOTE: the breech will not open unless the bolt is in the backward position.

- Remove the screw located in the centre of the back plate **3**, using a suitable 2mm Allen key.
- Carefully lift the back plate off **4**.
- Remove the breech release knob **1** by unscrewing the locking screw **5** counter-clockwise.
- Remove the right hand grip cheek cover **6** by removing the 3 retaining screws using a metric 2mm Allen key.
- Unplug the Angel Eyes, battery and solenoid plugs **7**.
- Remove the 2 grip frame screws **8** holding the frame to the body using a suitable 3mm Allen key.
- Remove the grip frame **9** from the body.
- Withdraw the ram lock pin **10** located under the frame. The ram **11** can now be withdrawn as an assembly.

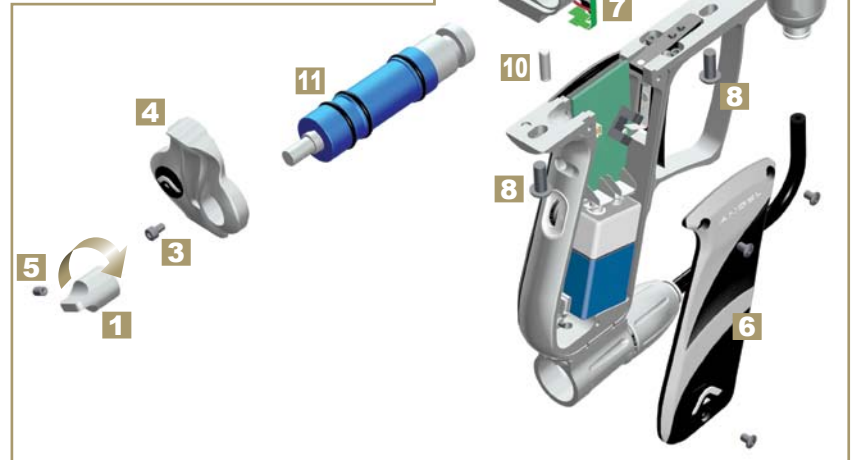
**IMPORTANT NOTES:**

For re-assembly of components

- Ensure the ram assembly is lubricated with Love Juice Extreme Grease prior to re-fitment.
- Ensure the ram assembly external O rings are not damaged.
- Ensure the ram assembly is inserted slowly to prevent damage to the O rings.

NOTE: WHEN RECONNECTING THE EYE RIBBONS TO THE PCB THE SHORTER RIBBON CONNECTS TO TOP ZIF SOCKET.

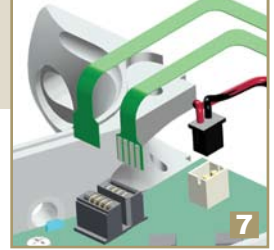

Magnetic adjustable force trigger - Front and back stop position adjustment

The trigger system has four adjustable points, front stop, back stop, activation point, and magnetic return strength control.

When adjusting the trigger it is advisable to set both the front and back stop positions before you proceed to set the return strength or activation point.

Adjusting the front stop position



- Insert a 2mm Allen key into the foremost set screw **1** in the trigger.
- To move the front stop point **forwards** turn the set screw **counter clockwise**.
- To move the front stop point **backwards** turn the set **screw clockwise**.

Note: It is important to not over adjust the front stop position set screw in this direction as it will result in not enough return travel for the trigger to reset the switch.

Adjusting the back stop position

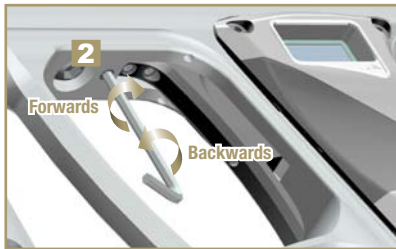

- Insert a 2mm Allen key into the set screw located in the underside of the grip frame **2**.
- To move the back stop position **forwards** turn the set screw **clockwise**.

Note: It is important to not over adjust the back stop position set screw in this direction as it will result in not enough travel for a trigger pull to activate the switch

- To move the back stop position **backwards** turn the set screw **counter clockwise**.

Adjusting the return strength

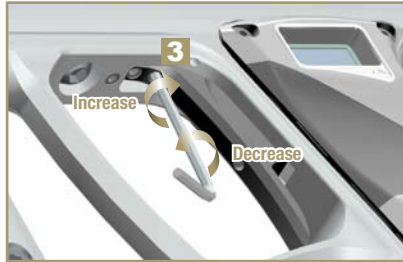

- Insert a 2mm Allen key into the rearmost set screw **3** in the trigger.
- To **increase** the return strength turn the set screw **clock wise**.
- To **decrease** the return strength turn the set screw **counter clockwise**.

It is important not to over adjust this portion of the trigger as it will negate the position of the front stop set screw for this reason it is advisable that during the set up of the trigger you should wind the magnetic return strength adjuster screw counter clock wise several turns so that it does not interfere with the adjustment of the front stop set screw.

ANGEL 1

29

⚠ WARNING

ADHERE STRICTLY TO THESE AND ALL OTHER SAFETY INSTRUCTIONS AND GUIDELINES

- Ensure a barrel blocking device is fitted to the ANGEL.
- Ensure the hopper is removed from the ANGEL.
- Ensure that there are no paintballs in the ANGEL.
- Always remove the first stage regulator and release all residual gas pressure from the Angel before disassembly.
- The Angel can hold a small residual gas charge, typically two shots, with the first stage regulator removed. Always discharge the Angel in a safe direction to relieve this residual gas pressure.
- NEVER adjust your trigger so fine that accidental discharge can occur due to shock loads or vibration.
- SHOULD YOU BE UNSURE AT ANY STAGE YOU MUST SEEK EXPERT ADVICE.

⚠ WARNING**ADHERE STRICTLY TO THESE
AND ALL OTHER SAFETY
INSTRUCTIONS AND GUIDELINES**

- Ensure a barrel blocking device is fitted to the ANGEL.
- Ensure the hopper is removed from the ANGEL.
- Ensure that there are no paintballs in the ANGEL.
- Always remove the first stage regulator and release all residual gas pressure from the Angel before disassembly.
- The Angel can hold a small residual gas charge, typically two shots, with the first stage regulator removed. Always discharge the Angel in a safe direction to relieve this residual gas pressure.
- NEVER adjust your trigger so fine that accidental discharge can occur due to shock loads or vibration.
- SHOULD YOU BE UNSURE AT ANY STAGE YOU MUST SEEK EXPERT ADVICE.

Trigger activation position

- Insert a 2mm Allen key into the activation position set screw **1**.
- To move the activation point closer towards the start of the trigger pull turn the set screw **clockwise**.
- To move the activation point closer towards the end of the trigger pull turn the set screw **counter clockwise**.

**Wiring connections**

- Ensure that the Angel is de-gassed and switched off.
- Remove the right hand side grip cheek cover by removing the 3 retaining screws using a suitable 2mm Allen key.
- Access to the PCB and its wiring connections is now gained.

Important notes for re assembly of components.

- Do not trap any wiring or damage could occur to the wiring resulting in a fault developing.
- Do not pull the plugs out from the PCB by the wiring always use a suitable tool to extract the plug from its socket.



NOTE: WHEN RECONNECTING THE EYE RIBBONS TO THE PCB THE SHORTER RIBBON CONNECTS TO TOP ZIFF SOCKET.

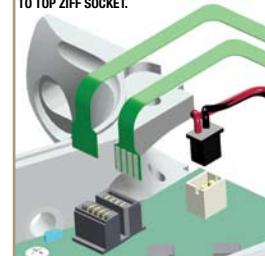

PROBLEM	SOLUTION	PAGE
ANGEL WILL NOT FIRE		
No air or nitrogen present?	Propellant Air/Nitrogen Supply .	6
Is the battery operational?	Change the battery	4
Is the ANGEL in 'SAFE'	Making the ANGEL 'LIVE'.	3/4
Is the trigger not closing the switch?	Trigger Adjustment.	29/30
Is the trigger not releasing the switch?	Trigger Adjustment.	29/30
Is the bolt jammed forward?	Clear the blockage from breech.	–
Is the LPR set correctly?	LPR Adjustment.	24
Is the OPTO Trigger functioning?	Trigger Adjustment.	29/30
Are the connectors plugged in correctly?	Wiring Connections	30
Are the Angel Eyes switched on?	Ensure paint is present	–
Are the Angel Eyes optics blocked	Clean the Angel Eyes Optics	–

VELOCITY VARIATIONS

Are good quality paintballs been used?	Use good paintballs.	–
Is the barrel bore correct for the paint?	Use suitable barrel.	–
Is the paint swollen, cold or hot?	Review your storage of paint.	–
Is the barrel bore clean?	Clean the barrel.	–
Is the tank reg choking on gas supply?	Check tank regulator assembly.	–
Is the tank reg operating correctly?	Check tank regulator assembly.	–
Is the mini-reg operating correctly?	Mini-Regulator Service.	20
Is the mini-reg choking on gas supply?	Mini-Regulator Service.	20
Are unsuitable after market parts fitted?	Use genuine ANGEL parts.	–
Is the bolt worn?	Replace Soft Bolt.	7
Is the LPR set correctly?	LPR Adjustment.	24
Is the valve dwell set correctly?	Dwell Adjustment.	13
Is first shot low?	Increase Dwell Time	13

VELOCITY TOO LOW / HIGH

Is the high pressure reg set correctly?	Check at gas source.	6
Is velocity adjuster screw set correctly?	Velocity adjustment.	7
Is the bolt sticking?	Check rubber finger detents.	21
Is the LPR set correctly?	LPR Adjustment.	24
Is the valve dwell set correctly?	Dwell Adjustment.	13

GAS LEAKING

From the back cover?	Check solenoid valve.	19
From the Ram assembly?	Check ram body O rings.	28
From the gas joints?	Check all fittings.	18/19
From exhaust valve?	Exhaust valve stem/guide.	27

Useful conversions

Listed are some useful conversions relating to pressure, velocity, mass and distance.

PRESSURE

1 atm = 1.01325 bar
 1 atm = 14.6959 psi
 1 bar = 14.5038 psi
 1 psi = 0.0689476 bar

VELOCITY

1 Ft/s = 0.3048 m/s
 1 Ft/s = 0.6818180 Mph
 1 m/s = 3.28084 Ft/s
 1 m/s = 2.23694 Mph
 1 m/s = 3.6 Kph

MASS

1 g = 0.05274 oz
 1 Kg = 2.20462 lb
 1 oz = 0.0283495 Kg

DISTANCE

1 mm = 0.0393701 Inch
 1 Inch = 25.4mm
 1 thou = 25.4 micron
 1 micron = 0.0393701 thou

FORMULA TO CONVERT FEET PER SECOND (Ft/s) TO FOOT Lbs (Force)

1 foot lbs (force) = 1.35582 Joules
 1 Joule = 0.737562 foot lbs (force)
 1 Gram = 15.4324 Grains
 1 Grain = 0.000142857 lb
 1 lb = 7000 Grains

Velocity squared x Projectile weight
 VELOCITY = Ft/s (feet per second)
 PROJECTILE WEIGHT = GRAINS
 Therefore a paintball @ 3.2grams @ 300Ft/s= 9.9 foot lbs (ftlbs)

Fault finding

PROBLEM	SOLUTION	PAGE
BREAKING PAINTBALLS		
Is the paint too fragile?	Use less fragile paint.	–
Is the barrel bore correct for the paint?	Use suitable barrel.	–
Is the paint swollen, cold, hot?	Review your storage of paint.	–
Are the Angel Eyes switched on?	Switching Angel Eyes On	5
Are the Angel Eyes functioning?	Angel Eyes Test.	5/22
Is the loader battery weak/dead?	Replace batteries.	–
Is a suitable working loader fitted?	See Loader section	–
Is the correct loader setting selected?	Change Loader Type settings	15
Is the rate of fire set too high?	MROF Adjustment.	14
Are the rubber finger detents functioning?	Clean or replace.	21
Is the paint too fragile for the loader?	Change paint to tougher grade	–
CHOPPING PAINTBALLS		
Is the loader battery weak/dead?	Replace batteries.	–
Is a suitable working loader fitted?	Replace loader.	–
Is the loader dirty?	Clean loader.	–
Are the paintballs swollen?	Replace the paintballs.	–
Are the Angel Eyes switched on?	Switching Angel Eyes On	5
Are the Angel Eyes functioning?	Angel Eyes Test.	5/22
Is the correct loader setting selected?	Change Loader Type settings	15
Is the Rate Of Fire set too high?	MROF Adjustment.	14
Are the rubber finger detents functioning?	Clean or replace.	21
FIRING TOO SLOW		
Is the rate of fire set correctly?	MROF Adjustment.	14
Is the loader battery weak/dead?	Replace batteries	–
Is a suitable working loader fitted?	Replace loader	–
Is the loader dirty?	Clean loader	–
Are the Angel Eyes switched on?	Switching Angel Eyes On	5
Is the correct loader setting selected?	Change Loader Type settings	15
Is the Rate Of Fire set too low?	MROF Adjustment.	14
EXCESSIVE NOISE / GAS CONSUMPTION		
Is the valve Dwell set correctly?	Dwell Adjustment.	13
Is the LPR pressure set correctly?	LPR Adjustment.	24
Is the exhaust valve worn?	Exhaust Valve replacement.	27
Is the barrel bore correct for the paint?	Use suitable barrel.	–

Terms of warranty - EEC/R.O.W. Excluding USA / Canada

Subject to the conditions set out below WDP warrants that the ANGEL will correspond to its specification at the time of delivery and will be free from defects in materials and workmanship for a period of six months from the date of purchase.

WDP gives this warranty subject to the following conditions:

- Proof of purchase is required in all warranty claims.
- Warranty is not transferable.
- The company shall be under no liability in respect of any defect arising from fair wear and tear.
- Seals, batteries, wiring, circuit boards, displays and exhaust valves are not covered by this warranty. Wilful damage, negligence, abnormal working conditions, weather, accident, tampering, failure to follow manufacturers instructions (whether oral or in writing), misuse or alteration or repair of the ANGEL without the company's written approval will invalidate this warranty and the company shall be under no obligation whatsoever to the purchaser in respect of any of the above breaches of this warranty.
- The above warranty does not extend to parts, materials or equipment not manufactured by the company, in respect of which the purchaser shall only be entitled to the benefit of any such warranty or guarantee as given by the manufacturer to the company.

This warranty does not cover the following:

- Repairs, alterations or replacements not authorised by the manufacturer.
- The gradual reduction in performance linked to the age of the ANGEL or usage.
- Anything caused directly or indirectly by vandalism or theft.
- Any damage to parts which are recalled by the Manufacturer.
- Any loss, damage or failure, which a qualified engineer appointed by the Manufacturer, believes could have been avoided or was totally or partly caused by a lack of maintenance.

Subject as expressly provided in these conditions and except where the goods are sold to a person dealing as a consumer (within the meaning of the Unfair Contract Terms Act 1977) all warranties, conditions or other terms implied by statute or common law are excluded to the fullest extent permitted by law.

Where the goods are sold under a consumer transaction (as defined by the Unfair Terms in Consumer Contracts Regulations 1994 S13159) the statutory rights of the purchaser are not affected by these conditions. Carriage charges in relation to warranty claims shall be borne by the customer.

Where any valid claim in respect of the ANGEL is based in the quality or condition of the ANGEL or its failure to meet specification, and such valid claim is notified to the company in writing and is in accordance with the company's standard terms and conditions of sale, the company shall be entitled to repair or replace the goods or the part in question free of charge or, at the company's sole discretion, refund to the purchaser the price of the goods (or a proportionate part of the price) but the company shall have no further liability to the purchaser.

Except in respect of death or personal injury caused by the company's negligence, the company shall not be liable to the purchaser by reason of any representation, or any implied warranty, condition or other term, or any duty at common law, or under the express terms of this guarantee, for any direct or indirect, special or consequential loss or damage, whether to persons or property, costs, expenses or other claims for compensation or damages whatsoever (whether caused by the negligence of the company, its employees or agents or otherwise) which arise out of or in connection with the supply of the ANGEL its use, or misuse, or resale by the purchaser, or any individual, and the entire liability of the company under or in connection with the purchase or use or misuse of the ANGEL shall not exceed the purchase price of the ANGEL. Purchaser agrees to adhere strictly to all warnings and safety procedures and the contents of the Operator's Manual.

ANGEL 1



Terms of warranty - EEC/R.O.W. Excluding USA / Canada

The laws of England shall govern this warranty and the purchaser agrees to submit to the non-exclusive jurisdiction of the English courts.

The supply and purchase of the ANGEL is subject to the company's standard terms and conditions of sale, a copy of which is available on request. ANGEL patents applied for, design rights and all rights reserved. The ANGEL is marketed and distributed by WDP Ltd. Company registered in England No. 2114341 and WDP Paintball Inc. registered in USA No. 2479769.

No warranty is given to parts not manufactured by the manufacturer and all liability for loss damage or injury is excluded.

This warranty must be construed and read in conjunction with the products terms and conditions of sale.

To make a warranty claim, buyer must first contact the nearest authorised ANGEL Service Centre for instructions. A list of authorised ANGEL Service Centres may be obtained through WDP website: www.wdp.tv, or by contacting WDP by mail at WDP, Metro Triangle, 221 Mount Street, Nechells, Birmingham, England B7 5QT, or by fax at +(44) (0)121 327 3967, or by calling +(44) (0)121 328 2228.

1. General Express Warranties.

WDP warrants to the buyer who is purchasing to place into use (Buyer) only, that the ANGEL (Product) shall be free from material manufacturing defects in materials and workmanship for six months from the date of purchase, subject to the requirements, disclaimers and limitations of this Warranty. This is not a Warranty of performance, but a limited Warranty as to the condition of the Product at the beginning of the Warranty period, this Warranty is only against such defects and not against any other failures such as, but not limited to, those due to wear and tear, exposure to the elements, unusual operating environments, misuse, negligence, accident, alteration or repair in any respect which, in the judgement of WDP, adversely affects the condition or operation of the Product. Normal maintenance and perishable items such as seals, batteries, wiring, indicator lamps and exhaust valves are excluded from this limited Warranty against defects. This Warranty is not transferable and it may not be waived or expanded except in writing signed by WDP. The terms and limitations of this Warranty shall also apply to any additional goods or information, which may be distributed by WDP, relating to the ANGEL.

2. Disclaimer and Limitation of Express and Implied Warranties.

There are no express Warranties other than those contained in this Warranty. Whether or not the Product is to be used exclusively by Buyer, there shall be no third party beneficiaries to this Warranty herein. NO WARRANTY IS PROVIDED TO DISTRIBUTORS OR DEALERS EXCEPT AS MAY BE EXPRESSLY PROVIDED IN A SEPARATE AGREEMENT OF SALE. All descriptions, illustrations of the Product and other information in catalogues, brochures and price lists or otherwise provided by WDP or others are intended for general information only. WDP, is not responsible for any errors or omissions therein or for any loss or damage resulting from reliance on them. WDP, does not warrant that the Product is in compliance with any law or industry standards, guidelines or procedures. WDP standard terms and conditions of sale also apply if Buyer is a direct

purchaser from WDP. WDP DISCLAIMS ALL IMPLIED WARRANTIES INCLUDING, BUT NOT LIMITED TO, THOSE OF FITNESS FOR A PARTICULAR PURPOSE AND MERCHANTABILITY.

3. Remedy and Limitation of WDP liability.

Defective or non-conforming Product or parts thereof discovered and returned to WDP freight prepaid, with proof of purchase, during the Warranty period shall be repaired or replaced by WDP without any additional charge and shipped to Buyer, FOB WDP. In lieu of repair or replacement, if WDP elects, WDP may, upon return of such product and making a determination of non-conformity or defect, keep the product and refund the purchase price paid by Buyer. Buyer's remedies shall be limited (even in the event of WDP default of its Warranty obligations) exclusively to those provided in this Warranty. UNDER NO CIRCUMSTANCES SHALL WDP OR ANY SUPPLIER, DISTRIBUTOR, DEALER, OR OTHER PERSON BE LIABLE FOR EXEMPLARY, PUNITIVE, CONSEQUENTIAL OR INCIDENTAL DAMAGES, NOR FOR ANY AMOUNT IN EXCESS OF THE BUYER'S PURCHASE PRICE. Buyer waives any causes of action or theories of liability including, but not limited to, those arising under contract, tort, strict liability, Product liability, statutes, or otherwise, except as to those specifically provided by the Uniform Commercial Code (as adopted in Michigan) as excluded, modified and limited in this warranty.

4. Additional Consumer Protection.

The products are offered for sale for end use in supervised commercial establishments where professional safety codes are enforced, and not for personal, family or household use. Nevertheless, if the Product is determined in a transaction to be a customer Product under applicable law, the following provisions shall become applicable:

- (a) THE IMPLIED WARRANTIES OF MERCHANTABILITY OR FITNESS OF THE PRODUCT FOR A PARTICULAR PURPOSE THAT CANNOT BE DISCLAIMED ARE LIMITED IN DURATION TO THE INITIAL EXPRESS WARRANTY PERIOD.
- (b) Some states do not allow limitations on how long

Terms of warranty - USA / Canada

an implied Warranty lasts, so the above limitation in (a) may not apply.

- (c) Some states do not allow the exclusion or limitation of incidental or consequential damages, so such limitations may not apply.
- (d) And this Warranty gives buyer specific legal rights, and buyer may also have other rights provided for by law.

5. Parts, Service and Training performed by WDP

All Warranty and non-Warranty parts, labour and service, if any, provided by WDP related to the product are subject to all limitations and disclaimers of warranties and remedies provided in this Warranty. The replacement or repair of a product by WDP does not give rise to any new Warranty except the Warranty period provided for herein shall be extended by the length of any period in which defective or non-conforming product is in possession of WDP. WDP may have access to the Product after purchase of the Product. WDP is not under any duty to inspect the product for any defects or any improper use or modification of the Product, nor to correct or advise anyone of any such condition, use or modification, which is observed. Any notification, which may be given, is voluntary and subject to all limitations and disclaimers in this Warranty.

6. User's Responsibility for Safety and Indemnification

It is Buyer's or other user's responsibility to obtain all training and means that may be necessary to effectively protect all individuals and property from damage and bodily injury, which otherwise may result from the use or maintenance of the Product, and to use the Product in accordance with operating instructions and due care.

If operating instructions are not provided with the Product or have been lost, a copy will be provided by WDP without cost on request. Buyer shall use and shall require all others to use all safety devices and guards furnished with or intended to be used with the Product, and to follow proper safe operating procedures in accordance with general industry standards and as set forth in manuals and instruction information furnished by WDP. If Buyer fails to comply with the obligations set forth in this section, the buyer shall defend and indemnify WDP harmless from any claim, liability or obligation incurred by WDP or its suppliers, distributors, or dealers to persons injured directly or indirectly in connection with the use of the product contrary to this Warranty or any warning or instruction from WDP.

7. Law and Jurisdiction.

This Warranty shall be governed by the laws of Michigan, and Buyer irrevocably submits to the non-exclusive jurisdiction of courts sitting in Michigan to resolve all disputes arising from or related to this warranty or use of the Product.

8. Claims and information procedure.

To make a warranty claim, Buyer must first contact the nearest authorised ANGEL Service Centre for instructions. A list of authorised ANGEL Service Centres may be obtained through WDP website: www.wdp.tv, or by contacting WDP by mail at: WDP, Metro Triangle, 221 Mount Street, Nechells, Birmingham, England, B7 5QT, or by fax at +44 (0)121 327 3967, or by calling +44 (0)121 328 2228.